

MEASUREMENT REPORT

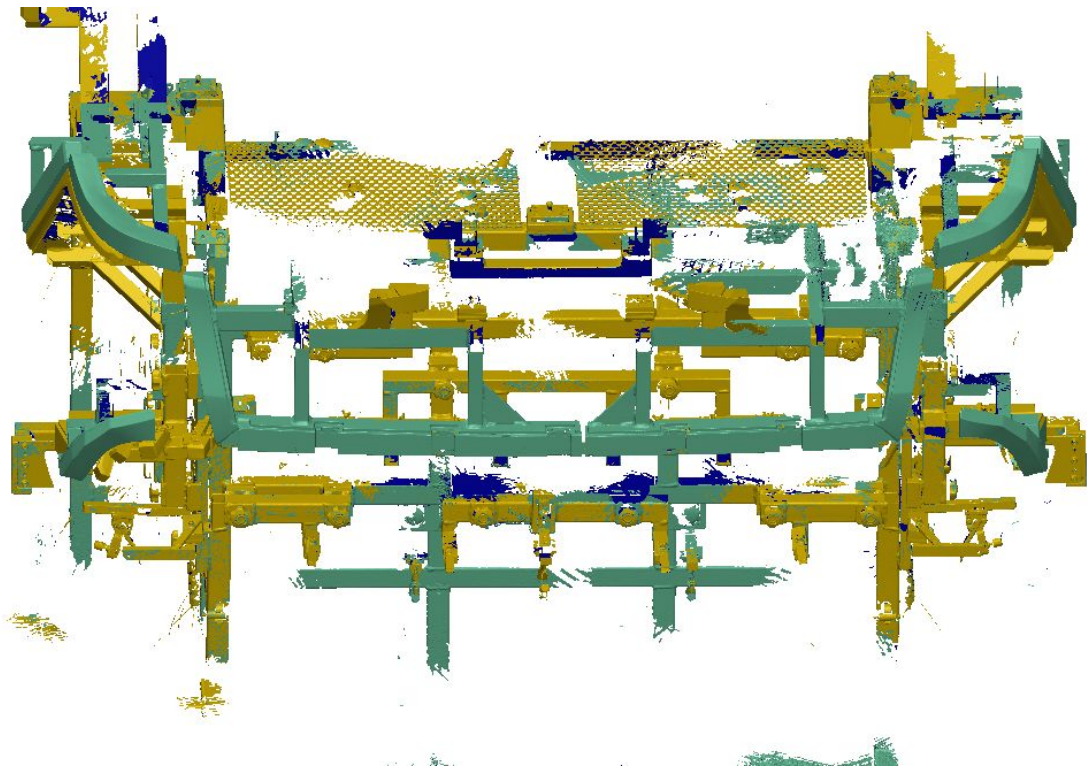

| | | | |
|------------|--|--------------|-----------------------|
| Customer: | HONDA DE MEXICO | Part name: | B-ZYD25C |
| Operator: | Felipe Martinez | Part number: | 71501/2-3W0-ZZ00/A000 |
| E-mail: | felipe.martinez@mess.com.mx | Drawing : | S/R |
| Workspace: | PROGRAMAS HONDA | Device: | MESS-P-SESC-003 |
| Project: | B-ZYD25C_71501-2-3W0-ZZ00- A000_pieza 1 | | |

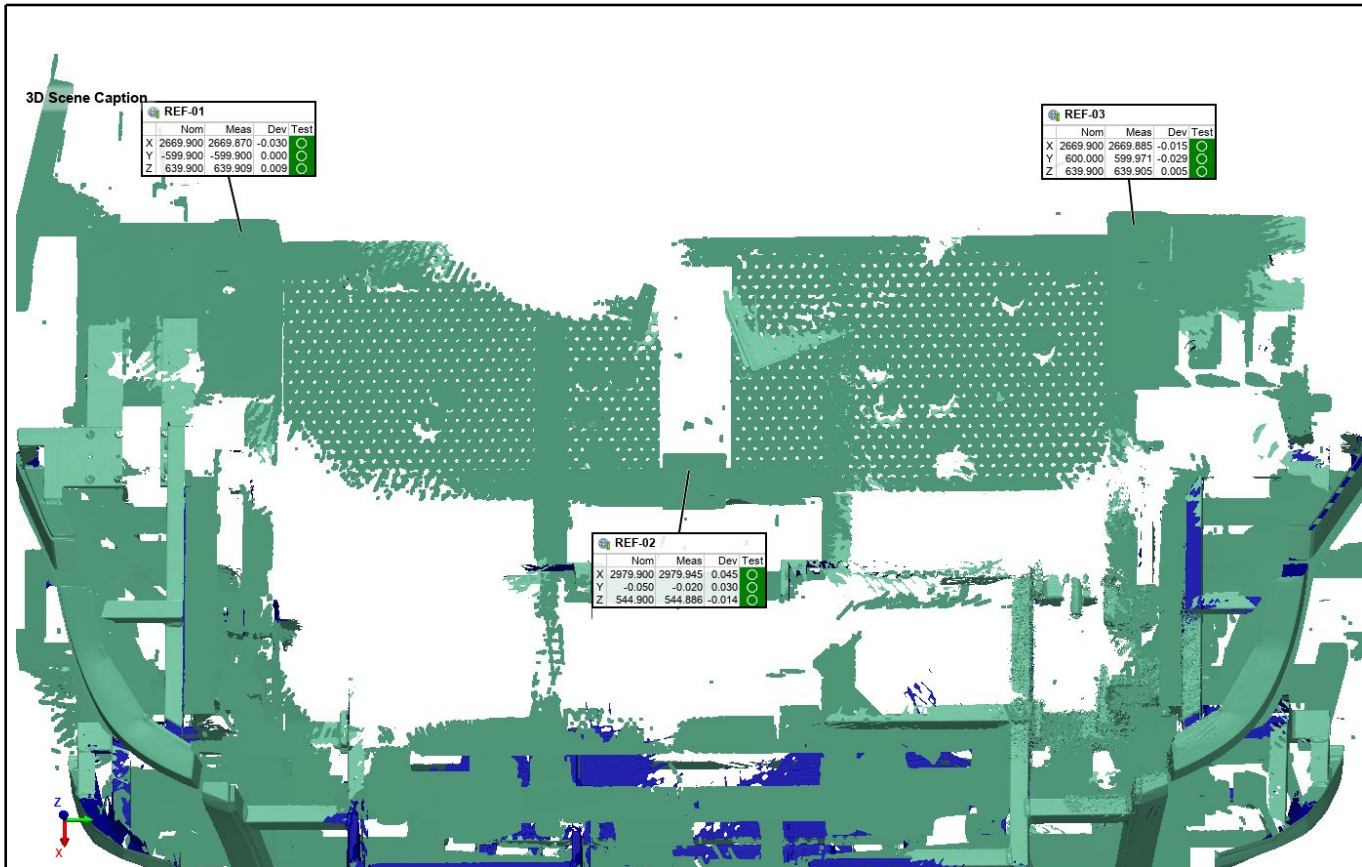



Feature Table

Length Units Millimeters

REF-01

| Control | Nom | Meas | Tol | Dev | Test |
|---------|----------|----------|--------|--------|------|
| X | 2669.900 | 2669.870 | ±0.100 | -0.030 | Pass |
| Y | -599.900 | -599.900 | ±0.100 | 0.000 | Pass |
| Z | 639.900 | 639.909 | ±0.100 | 0.009 | Pass |

REF-02

| Control | Nom | Meas | Tol | Dev | Test |
|---------|----------|----------|--------|--------|------|
| X | 2979.900 | 2979.945 | ±0.100 | 0.045 | Pass |
| Y | -0.050 | -0.020 | ±0.100 | 0.030 | Pass |
| Z | 544.900 | 544.886 | ±0.100 | -0.014 | Pass |

REF-03

| Control | Nom | Meas | Tol | Dev | Test |
|---------|----------|----------|--------|--------|------|
| X | 2669.900 | 2669.885 | ±0.100 | -0.015 | Pass |
| Y | 600.000 | 599.971 | ±0.100 | -0.029 | Pass |
| Z | 639.900 | 639.905 | ±0.100 | 0.005 | Pass |

Customer: HONDA DE MEXICO
 Operator: Felipe Martinez
 E-mail: felipe.martinez@mess.com.mx

Part name: B-ZYD25C
 Part number: 71501/2-3W0-ZZ00/A000
 Piece: piece 1



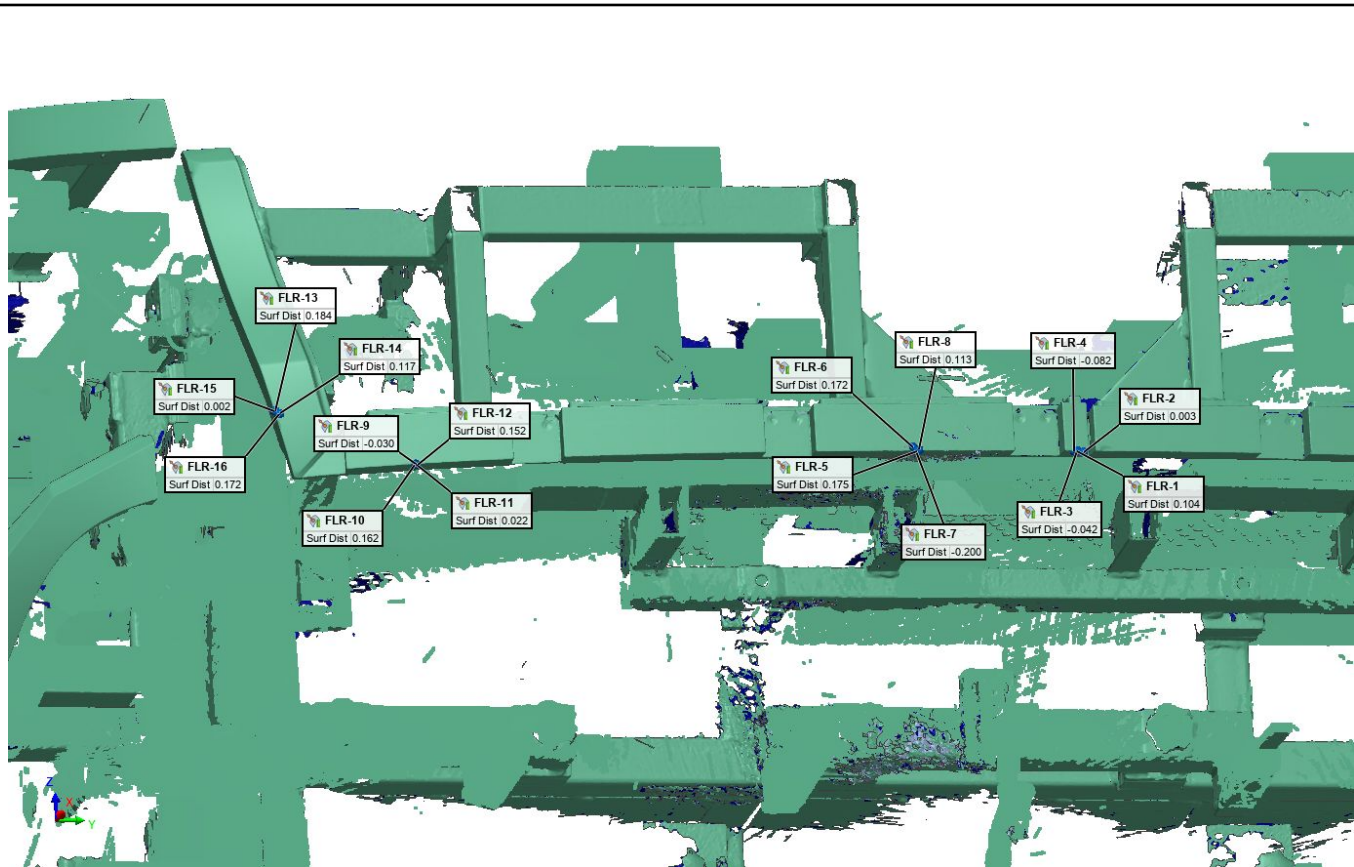

Comparison Point Table

Units Millimeters

| Name | Control | Nom | Meas | Tol | Dev | Test |
|-------|------------------|----------|----------|--------|--------|------|
| FLR-1 | Surface Distance | | 0.104 | ±0.200 | 0.104 | Pass |
| | Surface Point X | 3580.738 | 3580.661 | ±0.200 | -0.077 | Pass |
| | Surface Point Y | 29.981 | 29.980 | ±0.200 | -0.001 | Pass |
| | Surface Point Z | 350.882 | 350.952 | ±0.200 | 0.070 | Pass |
| FLR-2 | Surface Distance | | 0.003 | ±0.200 | 0.003 | Pass |
| | Surface Point X | 3580.847 | 3580.843 | ±0.200 | -0.004 | Pass |
| | Surface Point Y | 35.013 | 35.013 | ±0.200 | 0.000 | Pass |
| | Surface Point Z | 350.129 | 350.129 | ±0.200 | 0.000 | Pass |
| FLR-3 | Surface Distance | | -0.042 | ±0.200 | -0.042 | Pass |
| | Surface Point X | 3580.803 | 3580.789 | ±0.200 | -0.014 | Pass |
| | Surface Point Y | 29.992 | 29.992 | ±0.200 | 0.000 | Pass |
| | Surface Point Z | 350.710 | 350.670 | ±0.200 | -0.040 | Pass |
| FLR-4 | Surface Distance | | -0.082 | ±0.200 | -0.082 | Pass |
| | Surface Point X | 3577.847 | 3577.818 | ±0.200 | -0.029 | Pass |
| | Surface Point Y | 27.923 | 27.923 | ±0.200 | 0.000 | Pass |
| | Surface Point Z | 351.373 | 351.296 | ±0.200 | -0.077 | Pass |
| FLR-5 | Surface Distance | | 0.175 | ±0.200 | 0.175 | Pass |
| | Surface Point X | 3579.620 | 3579.674 | ±0.200 | 0.054 | Pass |
| | Surface Point Y | -99.995 | -100.009 | ±0.200 | -0.014 | Pass |

| | | | |
|-----------|-----------------------------|--------------|-----------------------|
| Customer: | HONDA DE MEXICO | Part name: | B-ZYD25C |
| Operator: | Felipe Martinez | Part number: | 71501/2-3W0-ZZ00/A000 |
| E-mail: | felipe.martinez@mess.com.mx | Piece: | piece 1 |



| | | | | | | |
|--------|------------------|----------|----------|--------|--------|------|
| FLR-6 | Surface Point Z | 350.871 | 350.705 | ±0.200 | -0.166 | Pass |
| | Surface Distance | | 0.172 | ±0.200 | 0.172 | Pass |
| | Surface Point X | 3579.525 | 3579.684 | ±0.200 | 0.159 | Pass |
| | Surface Point Y | -102.972 | -102.976 | ±0.200 | -0.004 | Pass |
| FLR-7 | Surface Point Z | 353.863 | 353.799 | ±0.200 | -0.064 | Pass |
| | Surface Distance | | -0.200 | ±0.200 | -0.200 | Pass |
| | Surface Point X | 3579.602 | 3579.581 | ±0.200 | -0.021 | Pass |
| | Surface Point Y | -100.045 | -100.028 | ±0.200 | 0.017 | Pass |
| FLR-8 | Surface Point Z | 350.463 | 350.662 | ±0.200 | 0.199 | Pass |
| | Surface Distance | | 0.113 | ±0.200 | 0.113 | Pass |
| | Surface Point X | 3579.695 | 3579.808 | ±0.200 | 0.113 | Pass |
| | Surface Point Y | -97.768 | -97.769 | ±0.200 | -0.001 | Pass |
| FLR-9 | Surface Point Z | 351.760 | 351.757 | ±0.200 | -0.003 | Pass |
| | Surface Distance | | -0.030 | ±0.200 | -0.030 | Pass |
| | Surface Point X | 3549.203 | 3549.189 | ±0.200 | -0.014 | Pass |
| | Surface Point Y | -500.004 | -499.999 | ±0.200 | 0.005 | Pass |
| FLR-10 | Surface Point Z | 347.347 | 347.373 | ±0.200 | 0.026 | Pass |
| | Surface Distance | | 0.162 | ±0.200 | 0.162 | Pass |
| | Surface Point X | 3546.394 | 3546.381 | ±0.200 | -0.013 | Pass |
| | Surface Point Y | -500.295 | -500.290 | ±0.200 | 0.005 | Pass |
| FLR-11 | Surface Point Z | 347.299 | 347.138 | ±0.200 | -0.161 | Pass |
| | Surface Distance | | 0.022 | ±0.200 | 0.022 | Pass |
| | Surface Point X | 3548.820 | 3548.831 | ±0.200 | 0.011 | Pass |
| | Surface Point Y | -499.940 | -499.944 | ±0.200 | -0.004 | Pass |
| FLR-12 | Surface Point Z | 347.133 | 347.114 | ±0.200 | -0.019 | Pass |
| | Surface Distance | | 0.152 | ±0.200 | 0.152 | Pass |
| | Surface Point X | 3547.462 | 3547.449 | ±0.200 | -0.013 | Pass |
| | Surface Point Y | -497.880 | -497.875 | ±0.200 | 0.005 | Pass |
| FLR-13 | Surface Point Z | 347.308 | 347.156 | ±0.200 | -0.152 | Pass |
| | Surface Distance | | 0.184 | ±0.200 | 0.184 | Pass |
| | Surface Point X | 3516.132 | 3516.298 | ±0.200 | 0.166 | Pass |
| | Surface Point Y | -603.867 | -603.943 | ±0.200 | -0.076 | Pass |
| FLR-14 | Surface Point Z | 400.134 | 400.109 | ±0.200 | -0.025 | Pass |
| | Surface Distance | | 0.117 | ±0.200 | 0.117 | Pass |
| | Surface Point X | 3516.996 | 3517.109 | ±0.200 | 0.113 | Pass |
| | Surface Point Y | -600.038 | -600.064 | ±0.200 | -0.026 | Pass |
| FLR-15 | Surface Point Z | 397.583 | 397.598 | ±0.200 | 0.015 | Pass |
| | Surface Distance | | 0.002 | ±0.200 | 0.002 | Pass |
| | Surface Point X | 3515.791 | 3515.791 | ±0.200 | 0.000 | Pass |
| | Surface Point Y | -604.170 | -604.171 | ±0.200 | -0.001 | Pass |
| FLR-16 | Surface Point Z | 400.054 | 400.054 | ±0.200 | 0.000 | Pass |
| | Surface Distance | | 0.172 | ±0.200 | 0.172 | Pass |
| | Surface Point X | 3516.733 | 3516.898 | ±0.200 | 0.165 | Pass |
| | Surface Point Y | -601.092 | -601.132 | ±0.200 | -0.040 | Pass |
| | Surface Point Z | 397.283 | 397.260 | ±0.200 | -0.023 | Pass |

Customer: HONDA DE MEXICO
 Operator: Felipe Martinez
 E-mail: felipe.martinez@mess.com.mx

Part name: B-ZYD25C
 Part number: 71501/2-3W0-ZZ00/A000
 Piece: piece 1



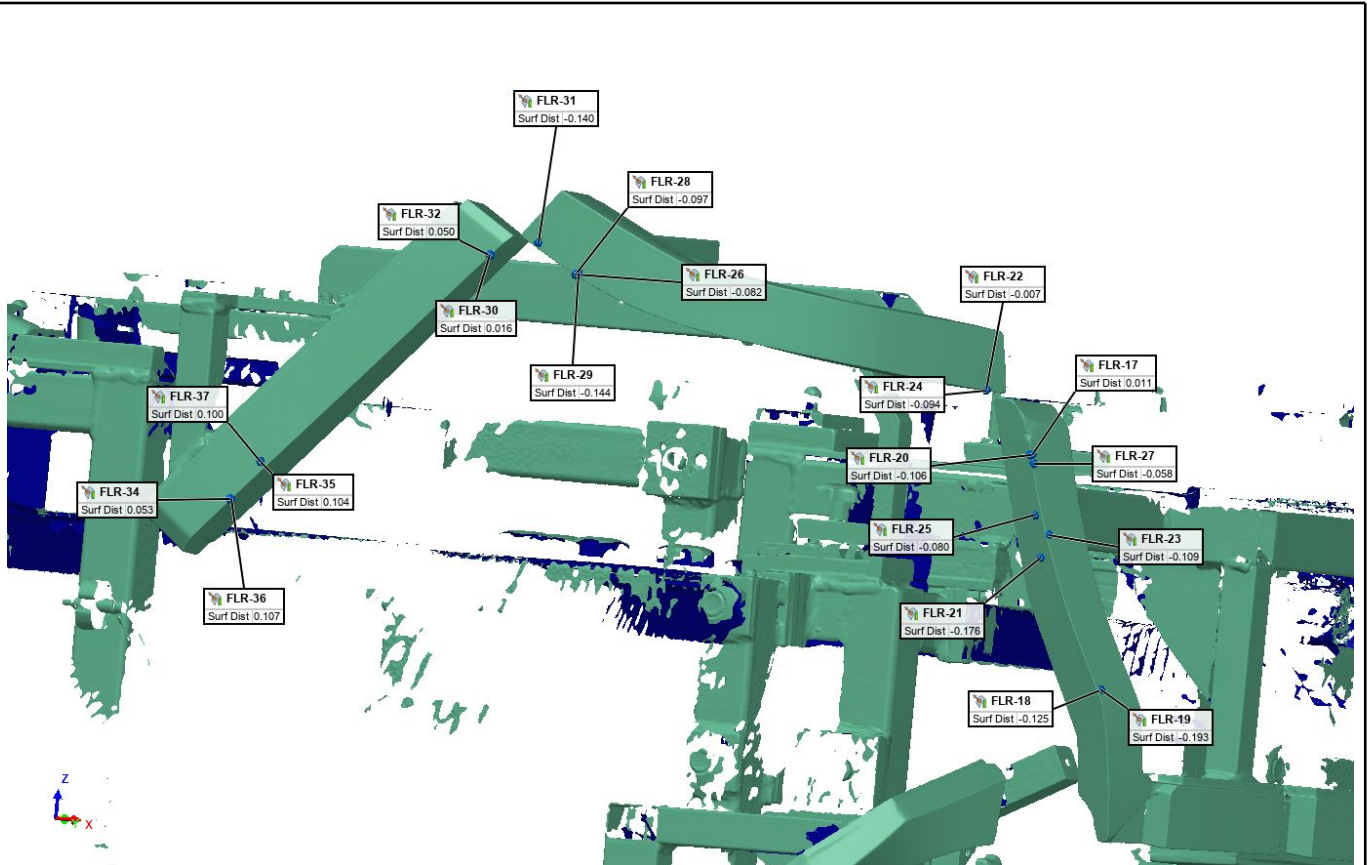

Comparison Point Table

Units: Millimeters

| Name | Control | Nom | Meas | Tol | Dev | Test |
|--------|------------------|----------|----------|--------|--------|------|
| FLR-17 | Surface Distance | | 0.011 | ±0.200 | 0.011 | Pass |
| | Surface Point X | 3458.686 | 3458.677 | ±0.200 | -0.009 | Pass |
| | Surface Point Y | -644.263 | -644.258 | ±0.200 | 0.005 | Pass |
| | Surface Point Z | 600.104 | 600.104 | ±0.200 | 0.000 | Pass |
| FLR-18 | Surface Distance | | -0.125 | ±0.200 | -0.125 | Pass |
| | Surface Point X | 3509.635 | 3509.737 | ±0.200 | 0.102 | Pass |
| | Surface Point Y | -611.734 | -611.759 | ±0.200 | -0.025 | Pass |
| | Surface Point Z | 447.104 | 447.172 | ±0.200 | 0.068 | Pass |
| FLR-19 | Surface Distance | | -0.193 | ±0.200 | -0.193 | Pass |
| | Surface Point X | 3509.635 | 3509.808 | ±0.200 | 0.173 | Pass |
| | Surface Point Y | -611.734 | -611.781 | ±0.200 | -0.047 | Pass |
| | Surface Point Z | 447.403 | 447.474 | ±0.200 | 0.071 | Pass |
| FLR-20 | Surface Distance | | -0.106 | ±0.200 | -0.106 | Pass |
| | Surface Point X | 3458.120 | 3458.163 | ±0.200 | 0.043 | Pass |
| | Surface Point Y | -644.552 | -644.647 | ±0.200 | -0.095 | Pass |
| | Surface Point Z | 599.952 | 599.937 | ±0.200 | -0.015 | Pass |
| FLR-21 | Surface Distance | | -0.176 | ±0.200 | -0.176 | Pass |
| | Surface Point X | 3465.950 | 3465.926 | ±0.200 | -0.024 | Pass |
| | Surface Point Y | -631.015 | -631.184 | ±0.200 | -0.169 | Pass |

Customer: HONDA DE MEXICO
 Operator: Felipe Martinez
 E-mail: felipe.martinez@mess.com.mx

Part name: B-ZYD25C
 Part number: 71501/2-3W0-ZZ00/A000
 Piece: piece 1



| | | | | | | |
|--------|------------------|----------|----------|--------|--------|------|
| | Surface Point Z | 532.115 | 532.155 | ±0.200 | 0.040 | Pass |
| FLR-22 | Surface Distance | | -0.007 | ±0.200 | -0.007 | Pass |
| | Surface Point X | 3433.132 | 3433.139 | ±0.200 | 0.007 | Pass |
| | Surface Point Y | -669.905 | -669.908 | ±0.200 | -0.003 | Pass |
| | Surface Point Z | 640.660 | 640.660 | ±0.200 | 0.000 | Pass |
| FLR-23 | Surface Distance | | -0.109 | ±0.200 | -0.109 | Pass |
| | Surface Point X | 3470.987 | 3471.089 | ±0.200 | 0.102 | Pass |
| | Surface Point Y | -632.865 | -632.894 | ±0.200 | -0.029 | Pass |
| | Surface Point Z | 547.661 | 547.685 | ±0.200 | 0.024 | Pass |
| FLR-24 | Surface Distance | | -0.094 | ±0.200 | -0.094 | Pass |
| | Surface Point X | 3432.834 | 3432.873 | ±0.200 | 0.039 | Pass |
| | Surface Point Y | -669.796 | -669.800 | ±0.200 | -0.004 | Pass |
| | Surface Point Z | 640.264 | 640.179 | ±0.200 | -0.085 | Pass |
| FLR-25 | Surface Distance | | -0.080 | ±0.200 | -0.080 | Pass |
| | Surface Point X | 3461.923 | 3461.912 | ±0.200 | -0.011 | Pass |
| | Surface Point Y | -636.792 | -636.871 | ±0.200 | -0.079 | Pass |
| | Surface Point Z | 560.002 | 559.993 | ±0.200 | -0.009 | Pass |
| FLR-26 | Surface Distance | | -0.082 | ±0.200 | -0.082 | Pass |
| | Surface Point X | 3200.208 | 3200.219 | ±0.200 | 0.011 | Pass |
| | Surface Point Y | -833.592 | -833.673 | ±0.200 | -0.081 | Pass |
| | Surface Point Z | 692.469 | 692.464 | ±0.200 | -0.005 | Pass |
| FLR-27 | Surface Distance | | -0.058 | ±0.200 | -0.058 | Pass |
| | Surface Point X | 3459.885 | 3459.940 | ±0.200 | 0.055 | Pass |
| | Surface Point Y | -642.607 | -642.624 | ±0.200 | -0.017 | Pass |
| | Surface Point Z | 594.277 | 594.284 | ±0.200 | 0.007 | Pass |
| FLR-28 | Surface Distance | | -0.097 | ±0.200 | -0.097 | Pass |
| | Surface Point X | 3199.990 | 3199.983 | ±0.200 | -0.007 | Pass |
| | Surface Point Y | -833.221 | -833.309 | ±0.200 | -0.088 | Pass |
| | Surface Point Z | 692.203 | 692.165 | ±0.200 | -0.038 | Pass |
| FLR-29 | Surface Distance | | -0.144 | ±0.200 | -0.144 | Pass |
| | Surface Point X | 3202.122 | 3202.151 | ±0.200 | 0.029 | Pass |
| | Surface Point Y | -833.156 | -833.297 | ±0.200 | -0.141 | Pass |
| | Surface Point Z | 693.371 | 693.370 | ±0.200 | -0.001 | Pass |
| FLR-30 | Surface Distance | | 0.016 | ±0.200 | 0.016 | Pass |
| | Surface Point X | 3141.850 | 3141.859 | ±0.200 | 0.009 | Pass |
| | Surface Point Y | -848.006 | -848.019 | ±0.200 | -0.013 | Pass |
| | Surface Point Z | 700.315 | 700.314 | ±0.200 | -0.001 | Pass |
| FLR-31 | Surface Distance | | -0.140 | ±0.200 | -0.140 | Pass |
| | Surface Point X | 3172.515 | 3172.536 | ±0.200 | 0.021 | Pass |
| | Surface Point Y | -838.382 | -838.521 | ±0.200 | -0.139 | Pass |
| | Surface Point Z | 711.439 | 711.439 | ±0.200 | 0.000 | Pass |
| FLR-32 | Surface Distance | | 0.050 | ±0.200 | 0.050 | Pass |
| | Surface Point X | 3142.040 | 3142.075 | ±0.200 | 0.035 | Pass |
| | Surface Point Y | -847.580 | -847.600 | ±0.200 | -0.020 | Pass |
| | Surface Point Z | 700.008 | 699.979 | ±0.200 | -0.029 | Pass |
| FLR-33 | Surface Distance | | -0.140 | ±0.200 | -0.140 | Pass |

Customer: HONDA DE MEXICO
 Operator: Felipe Martinez
 E-mail: felipe.martinez@mess.com.mx

Part name: B-ZYD25C
 Part number: 71501/2-3W0-ZZ00/A000
 Piece: piece 1



| | | | | | | |
|--------|------------------|----------|----------|--------|--------|------|
| | | 3172.512 | 3172.533 | ±0.200 | 0.021 | Pass |
| | Surface Point Y | -838.383 | -838.521 | ±0.200 | -0.138 | Pass |
| | Surface Point Z | 711.443 | 711.443 | ±0.200 | 0.000 | Pass |
| FLR-34 | Surface Distance | | 0.053 | ±0.200 | 0.053 | Pass |
| | Surface Point X | 2991.885 | 2991.914 | ±0.200 | 0.029 | Pass |
| | Surface Point Y | -903.299 | -903.344 | ±0.200 | -0.045 | Pass |
| | Surface Point Z | 521.725 | 521.724 | ±0.200 | -0.001 | Pass |
| FLR-35 | Surface Distance | | 0.104 | ±0.200 | 0.104 | Pass |
| | Surface Point X | 3008.704 | 3008.726 | ±0.200 | 0.022 | Pass |
| | Surface Point Y | -896.432 | -896.533 | ±0.200 | -0.101 | Pass |
| | Surface Point Z | 548.096 | 548.109 | ±0.200 | 0.013 | Pass |
| FLR-36 | Surface Distance | | 0.107 | ±0.200 | 0.107 | Pass |
| | Surface Point X | 2992.114 | 2992.195 | ±0.200 | 0.081 | Pass |
| | Surface Point Y | -903.006 | -903.036 | ±0.200 | -0.030 | Pass |
| | Surface Point Z | 521.484 | 521.421 | ±0.200 | -0.063 | Pass |
| FLR-37 | Surface Distance | | 0.100 | ±0.200 | 0.100 | Pass |
| | Surface Point X | 3008.535 | 3008.556 | ±0.200 | 0.021 | Pass |
| | Surface Point Y | -896.409 | -896.506 | ±0.200 | -0.097 | Pass |
| | Surface Point Z | 548.587 | 548.599 | ±0.200 | 0.012 | Pass |

Customer: HONDA DE MEXICO
 Operator: Felipe Martinez
 E-mail: felipe.martinez@mess.com.mx

Part name: B-ZYD25C
 Part number: 71501/2-3W0-ZZ00/A000
 Piece: piece 1



3D Scene Caption

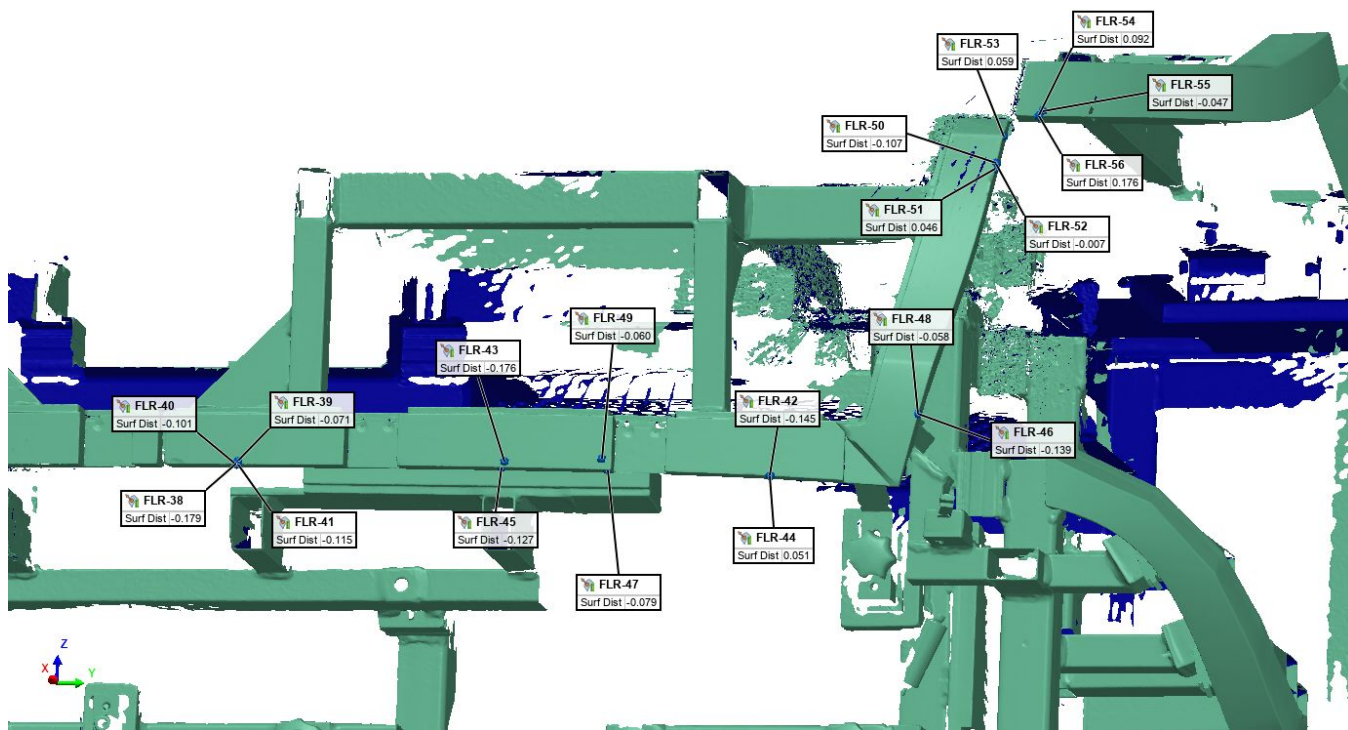

Comparison Point Table

Units Millimeters

| Name | Control | Nom | Meas | Tol | Dev | Test | Out Tol |
|--------|------------------|----------|----------|--------|--------|------|---------|
| FLR-38 | Surface Distance | | -0.179 | ±0.200 | -0.179 | Pass | |
| | Surface Point X | 3579.494 | 3579.512 | ±0.200 | 0.018 | Pass | |
| | Surface Point Y | 99.996 | 99.995 | ±0.200 | -0.001 | Pass | |
| | Surface Point Z | 350.925 | 350.747 | ±0.200 | -0.178 | Pass | |
| FLR-39 | Surface Distance | | -0.071 | ±0.200 | -0.071 | Pass | |
| | Surface Point X | 3579.456 | 3579.524 | ±0.200 | 0.068 | Pass | |
| | Surface Point Y | 101.448 | 101.470 | ±0.200 | 0.022 | Pass | |
| | Surface Point Z | 353.187 | 353.187 | ±0.200 | 0.000 | Pass | |
| FLR-40 | Surface Distance | | -0.101 | ±0.200 | -0.101 | Pass | |
| | Surface Point X | 3579.451 | 3579.414 | ±0.200 | -0.037 | Pass | |
| | Surface Point Y | 100.004 | 100.003 | ±0.200 | -0.001 | Pass | |
| | Surface Point Z | 350.404 | 350.311 | ±0.200 | -0.093 | Pass | |
| FLR-41 | Surface Distance | | -0.115 | ±0.200 | -0.115 | Pass | |
| | Surface Point X | 3576.364 | 3576.354 | ±0.200 | -0.010 | Pass | |
| | Surface Point Y | 100.391 | 100.390 | ±0.200 | -0.001 | Pass | |
| | Surface Point Z | 351.049 | 350.934 | ±0.200 | -0.115 | Pass | |
| FLR-42 | Surface Distance | | -0.145 | ±0.200 | -0.145 | Pass | |
| | Surface Point X | 3549.062 | 3549.125 | ±0.200 | 0.063 | Pass | |
| | Surface Point Y | 500.040 | 500.038 | ±0.200 | -0.002 | Pass | |

Customer: HONDA DE MEXICO
 Operator: Felipe Martinez
 E-mail: felipe.martinez@mess.com.mx

Part name: B-ZYD25C
 Part number: 71501/2-3W0-ZZ00/A000
 Piece: piece 1



| | | | | | | |
|--------|------------------|----------|----------|--------|--------|------|
| FLR-43 | Surface Point Z | 347.377 | 347.247 | ±0.200 | -0.130 | Pass |
| | Surface Distance | | -0.176 | ±0.200 | -0.176 | Pass |
| | Surface Point X | 3570.244 | 3570.400 | ±0.200 | 0.156 | Pass |
| | Surface Point Y | 302.041 | 302.052 | ±0.200 | 0.011 | Pass |
| FLR-44 | Surface Point Z | 354.159 | 354.080 | ±0.200 | -0.079 | Pass |
| | Surface Distance | | 0.051 | ±0.200 | 0.051 | Pass |
| | Surface Point X | 3548.827 | 3548.827 | ±0.200 | 0.000 | Pass |
| | Surface Point Y | 500.018 | 500.018 | ±0.200 | 0.000 | Pass |
| FLR-45 | Surface Point Z | 347.052 | 347.103 | ±0.200 | 0.051 | Pass |
| | Surface Distance | | -0.127 | ±0.200 | -0.127 | Pass |
| | Surface Point X | 3567.495 | 3567.483 | ±0.200 | -0.012 | Pass |
| | Surface Point Y | 299.427 | 299.425 | ±0.200 | -0.002 | Pass |
| FLR-46 | Surface Point Z | 350.307 | 350.180 | ±0.200 | -0.127 | Pass |
| | Surface Distance | | -0.139 | ±0.200 | -0.139 | Pass |
| | Surface Point X | 3516.185 | 3516.261 | ±0.200 | 0.076 | Pass |
| | Surface Point Y | 603.778 | 603.893 | ±0.200 | 0.115 | Pass |
| FLR-47 | Surface Point Z | 400.141 | 400.120 | ±0.200 | -0.021 | Pass |
| | Surface Distance | | -0.079 | ±0.200 | -0.079 | Pass |
| | Surface Point X | 3560.144 | 3560.137 | ±0.200 | -0.007 | Pass |
| | Surface Point Y | 378.426 | 378.424 | ±0.200 | -0.002 | Pass |
| FLR-48 | Surface Point Z | 349.625 | 349.546 | ±0.200 | -0.079 | Pass |
| | Surface Distance | | -0.058 | ±0.200 | -0.058 | Pass |
| | Surface Point X | 3515.787 | 3515.787 | ±0.200 | 0.000 | Pass |
| | Surface Point Y | 603.940 | 603.996 | ±0.200 | 0.056 | Pass |
| FLR-49 | Surface Point Z | 400.099 | 400.085 | ±0.200 | -0.014 | Pass |
| | Surface Distance | | -0.060 | ±0.200 | -0.060 | Pass |
| | Surface Point X | 3564.227 | 3564.283 | ±0.200 | 0.056 | Pass |
| | Surface Point Y | 374.458 | 374.467 | ±0.200 | 0.009 | Pass |
| FLR-50 | Surface Point Z | 357.600 | 357.618 | ±0.200 | 0.018 | Pass |
| | Surface Distance | | -0.107 | ±0.200 | -0.107 | Pass |
| | Surface Point X | 3458.461 | 3458.527 | ±0.200 | 0.066 | Pass |
| | Surface Point Y | 644.072 | 644.156 | ±0.200 | 0.084 | Pass |
| FLR-51 | Surface Point Z | 600.122 | 600.130 | ±0.200 | 0.008 | Pass |
| | Surface Distance | | 0.046 | ±0.200 | 0.046 | Pass |
| | Surface Point X | 3457.049 | 3457.055 | ±0.200 | 0.006 | Pass |
| | Surface Point Y | 643.441 | 643.397 | ±0.200 | -0.044 | Pass |
| FLR-52 | Surface Point Z | 595.946 | 595.955 | ±0.200 | 0.009 | Pass |
| | Surface Distance | | -0.007 | ±0.200 | -0.007 | Pass |
| | Surface Point X | 3458.039 | 3458.040 | ±0.200 | 0.001 | Pass |
| | Surface Point Y | 644.256 | 644.263 | ±0.200 | 0.007 | Pass |
| FLR-53 | Surface Point Z | 599.992 | 599.991 | ±0.200 | -0.001 | Pass |
| | Surface Distance | | 0.059 | ±0.200 | 0.059 | Pass |
| | Surface Point X | 3451.850 | 3451.858 | ±0.200 | 0.008 | Pass |
| | Surface Point Y | 647.625 | 647.567 | ±0.200 | -0.058 | Pass |
| FLR-54 | Surface Point Z | 621.622 | 621.633 | ±0.200 | 0.011 | Pass |
| | Surface Distance | | 0.092 | ±0.200 | 0.092 | Pass |

Customer: HONDA DE MEXICO
 Operator: Felipe Martinez
 E-mail: felipe.martinez@mess.com.mx

Part name: B-ZYD25C
 Part number: 71501/2-3W0-ZZ00/A000
 Piece: piece 1



| | | | | | | |
|--------|------------------|----------|----------|--------|--------|------|
| | | 3433.303 | 3433.234 | ±0.200 | -0.069 | Pass |
| | Surface Point Y | 669.982 | 669.950 | ±0.200 | -0.032 | Pass |
| | Surface Point Z | 640.650 | 640.701 | ±0.200 | 0.051 | Pass |
| FLR-55 | Surface Distance | | -0.047 | ±0.200 | -0.047 | Pass |
| | Surface Point X | 3432.111 | 3432.149 | ±0.200 | 0.038 | Pass |
| | Surface Point Y | 672.629 | 672.658 | ±0.200 | 0.029 | Pass |
| | Surface Point Z | 644.463 | 644.463 | ±0.200 | 0.000 | Pass |
| FLR-56 | Surface Distance | | 0.176 | ±0.200 | 0.176 | Pass |
| | Surface Point X | 3432.842 | 3432.843 | ±0.200 | 0.001 | Pass |
| | Surface Point Y | 669.799 | 669.794 | ±0.200 | -0.005 | Pass |
| | Surface Point Z | 640.192 | 640.368 | ±0.200 | 0.176 | Pass |

Customer: HONDA DE MEXICO
 Operator: Felipe Martinez
 E-mail: felipe.martinez@mess.com.mx

Part name: B-ZYD25C
 Part number: 71501/2-3W0-ZZ00/A000
 Piece: piece 1



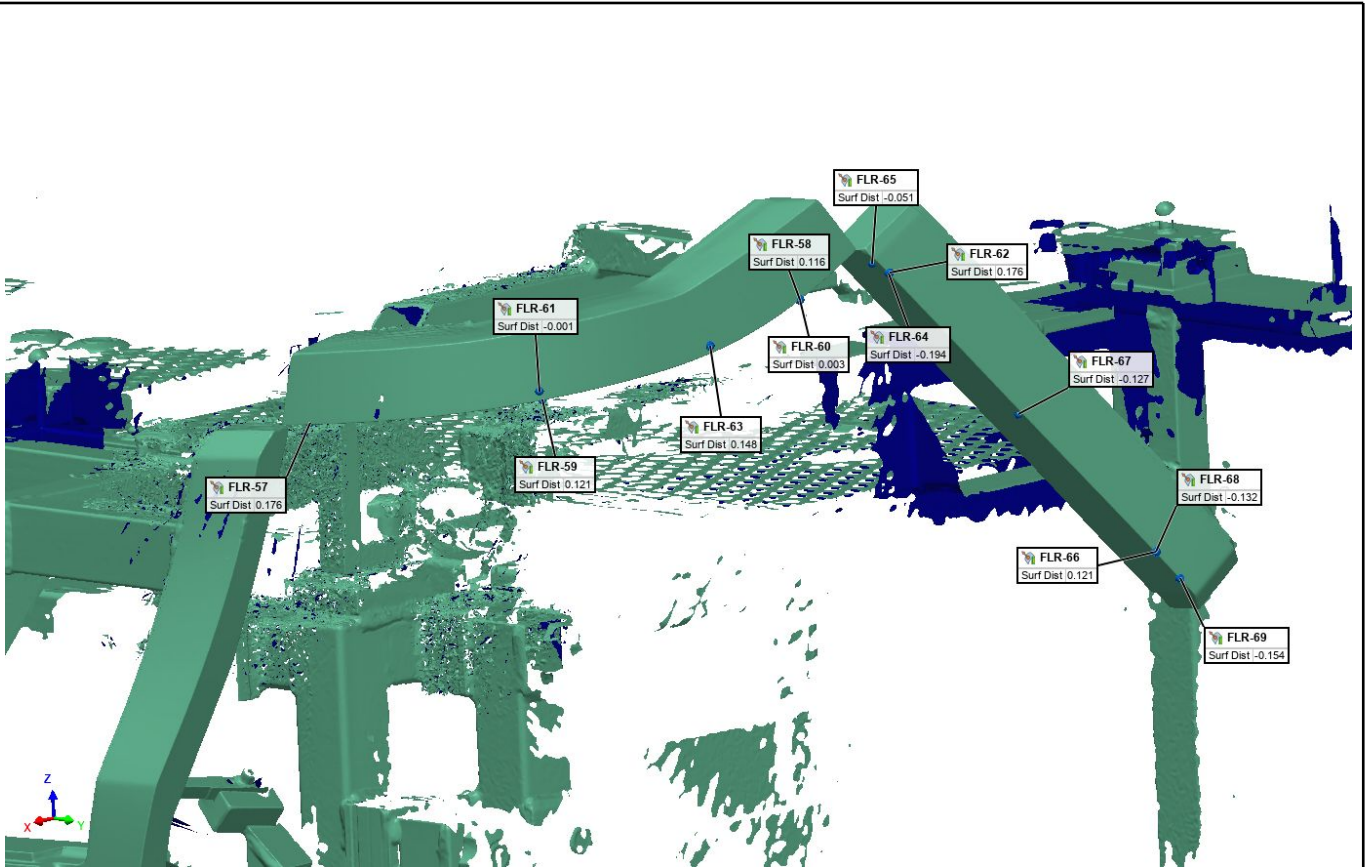

Comparison Point Table

Units Millimeters

| Name | Control | Nom | Meas | Tol | Dev | Test |
|--------|------------------|----------|----------|--------|--------|------|
| FLR-57 | Surface Distance | | 0.176 | ±0.200 | 0.176 | Pass |
| | Surface Point X | 3429.174 | 3429.184 | ±0.200 | 0.010 | Pass |
| | Surface Point Y | 664.998 | 664.992 | ±0.200 | -0.006 | Pass |
| | Surface Point Z | 640.231 | 640.406 | ±0.200 | 0.175 | Pass |
| FLR-58 | Surface Distance | | 0.116 | ±0.200 | 0.116 | Pass |
| | Surface Point X | 3200.251 | 3200.274 | ±0.200 | 0.023 | Pass |
| | Surface Point Y | 833.840 | 833.739 | ±0.200 | -0.101 | Pass |
| | Surface Point Z | 692.469 | 692.521 | ±0.200 | 0.052 | Pass |
| FLR-59 | Surface Distance | | 0.121 | ±0.200 | 0.121 | Pass |
| | Surface Point X | 3351.910 | 3351.923 | ±0.200 | 0.013 | Pass |
| | Surface Point Y | 774.862 | 774.856 | ±0.200 | -0.006 | Pass |
| | Surface Point Z | 652.218 | 652.338 | ±0.200 | 0.120 | Pass |
| FLR-60 | Surface Distance | | 0.003 | ±0.200 | 0.003 | Pass |
| | Surface Point X | 3199.930 | 3199.932 | ±0.200 | 0.002 | Pass |
| | Surface Point Y | 833.250 | 833.249 | ±0.200 | -0.001 | Pass |
| | Surface Point Z | 692.075 | 692.077 | ±0.200 | 0.002 | Pass |
| FLR-61 | Surface Distance | | -0.001 | ±0.200 | -0.001 | Pass |
| | Surface Point X | 3354.561 | 3354.562 | ±0.200 | 0.001 | Pass |
| | Surface Point Y | 775.577 | 775.578 | ±0.200 | 0.001 | Pass |

Customer: HONDA DE MEXICO
 Operator: Felipe Martinez
 E-mail: felipe.martinez@mess.com.mx

Part name: B-ZYD25C
 Part number: 71501/2-3W0-ZZ00/A000
 Piece: piece 1



| | | | | | | |
|--------|------------------|----------|----------|--------|--------|------|
| | Surface Point Z | 657.701 | 657.701 | ±0.200 | 0.000 | Pass |
| FLR-62 | Surface Distance | | 0.176 | ±0.200 | 0.176 | Pass |
| | Surface Point X | 3141.898 | 3141.850 | ±0.200 | -0.048 | Pass |
| | Surface Point Y | 848.142 | 847.978 | ±0.200 | -0.164 | Pass |
| | Surface Point Z | 700.318 | 700.360 | ±0.200 | 0.042 | Pass |
| FLR-63 | Surface Distance | | 0.148 | ±0.200 | 0.148 | Pass |
| | Surface Point X | 3259.065 | 3259.021 | ±0.200 | -0.044 | Pass |
| | Surface Point Y | 818.844 | 818.703 | ±0.200 | -0.141 | Pass |
| | Surface Point Z | 673.319 | 673.318 | ±0.200 | -0.001 | Pass |
| FLR-64 | Surface Distance | | -0.194 | ±0.200 | -0.194 | Pass |
| | Surface Point X | 3141.960 | 3142.120 | ±0.200 | 0.160 | Pass |
| | Surface Point Y | 847.565 | 847.596 | ±0.200 | 0.031 | Pass |
| | Surface Point Z | 700.082 | 699.975 | ±0.200 | -0.107 | Pass |
| FLR-65 | Surface Distance | | -0.051 | ±0.200 | -0.051 | Pass |
| | Surface Point X | 3147.244 | 3147.292 | ±0.200 | 0.048 | Pass |
| | Surface Point Y | 839.891 | 839.894 | ±0.200 | 0.003 | Pass |
| | Surface Point Z | 705.939 | 705.921 | ±0.200 | -0.018 | Pass |
| FLR-66 | Surface Distance | | 0.121 | ±0.200 | 0.121 | Pass |
| | Surface Point X | 2991.963 | 2991.928 | ±0.200 | -0.035 | Pass |
| | Surface Point Y | 903.676 | 903.561 | ±0.200 | -0.115 | Pass |
| | Surface Point Z | 521.769 | 521.756 | ±0.200 | -0.013 | Pass |
| FLR-67 | Surface Distance | | -0.127 | ±0.200 | -0.127 | Pass |
| | Surface Point X | 3066.189 | 3066.278 | ±0.200 | 0.089 | Pass |
| | Surface Point Y | 871.416 | 871.425 | ±0.200 | 0.009 | Pass |
| | Surface Point Z | 609.394 | 609.304 | ±0.200 | -0.090 | Pass |
| FLR-68 | Surface Distance | | -0.132 | ±0.200 | -0.132 | Pass |
| | Surface Point X | 2992.064 | 2992.140 | ±0.200 | 0.076 | Pass |
| | Surface Point Y | 903.021 | 903.112 | ±0.200 | 0.091 | Pass |
| | Surface Point Z | 521.536 | 521.478 | ±0.200 | -0.058 | Pass |
| FLR-69 | Surface Distance | | -0.154 | ±0.200 | -0.154 | Pass |
| | Surface Point X | 2977.977 | 2978.103 | ±0.200 | 0.126 | Pass |
| | Surface Point Y | 907.613 | 907.698 | ±0.200 | 0.085 | Pass |
| | Surface Point Z | 504.688 | 504.667 | ±0.200 | -0.021 | Pass |

Customer: HONDA DE MEXICO
 Operator: Felipe Martinez
 E-mail: felipe.martinez@mess.com.mx

Part name: B-ZYD25C
 Part number: 71501/2-3W0-ZZ00/A000
 Piece: piece 1



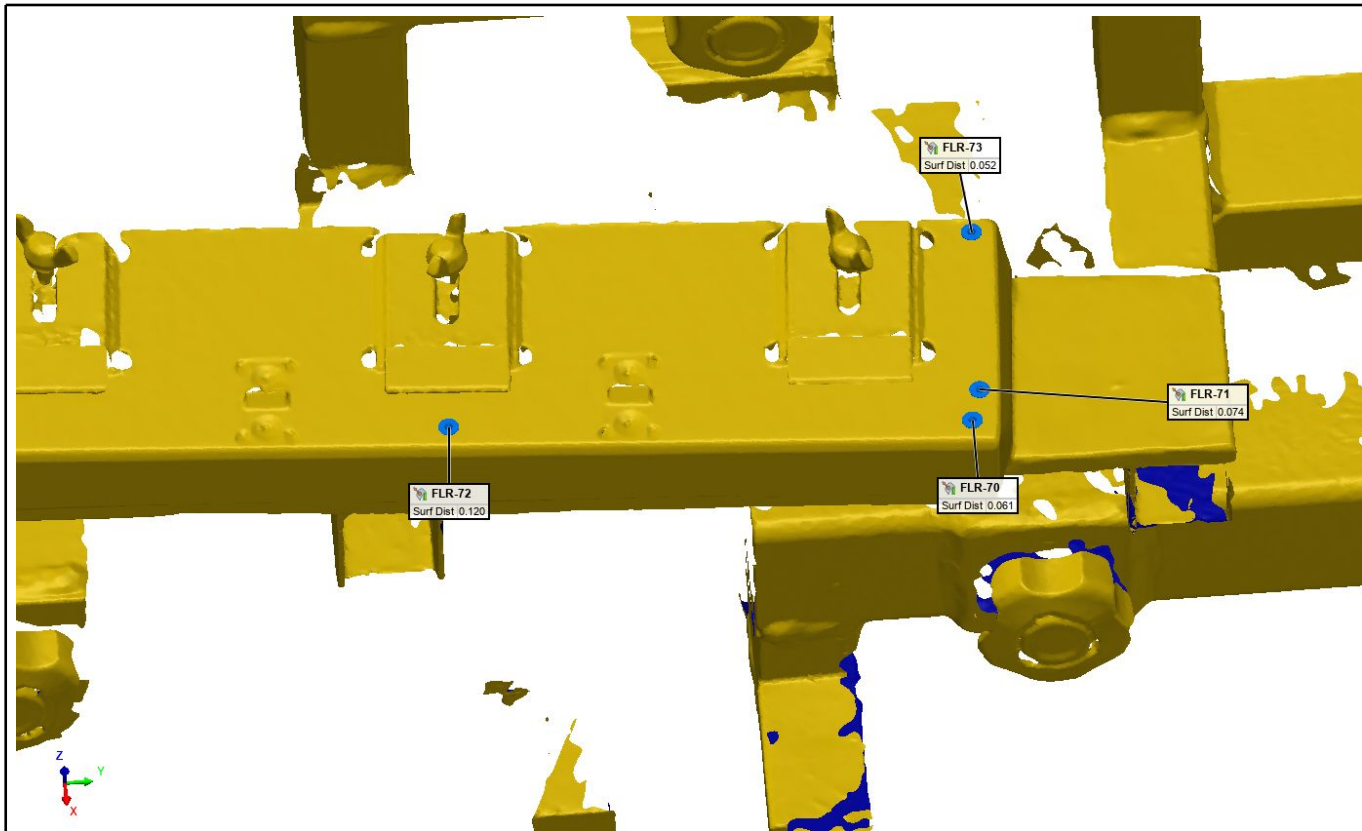

Comparison Point Table

Units Millimeters

| Name | Control | Nom | Meas | Tol | Dev | Test |
|--------|------------------|----------|----------|--------|--------|------|
| FLR-70 | Surface Distance | | 0.061 | ±0.200 | 0.061 | Pass |
| | Surface Point X | 3526.510 | 3526.510 | ±0.200 | 0.000 | Pass |
| | Surface Point Y | -147.770 | -147.770 | ±0.200 | 0.000 | Pass |
| | Surface Point Z | 366.032 | 366.093 | ±0.200 | 0.061 | Pass |
| FLR-71 | Surface Distance | | 0.074 | ±0.200 | 0.074 | Pass |
| | Surface Point X | 3517.600 | 3517.601 | ±0.200 | 0.001 | Pass |
| | Surface Point Y | -145.351 | -145.350 | ±0.200 | 0.001 | Pass |
| | Surface Point Z | 366.024 | 366.098 | ±0.200 | 0.074 | Pass |
| FLR-72 | Surface Distance | | 0.120 | ±0.200 | 0.120 | Pass |
| | Surface Point X | 3517.650 | 3517.649 | ±0.200 | -0.001 | Pass |
| | Surface Point Y | -272.460 | -272.461 | ±0.200 | -0.001 | Pass |
| | Surface Point Z | 365.992 | 366.112 | ±0.200 | 0.120 | Pass |
| FLR-73 | Surface Distance | | 0.052 | ±0.200 | 0.052 | Pass |
| | Surface Point X | 3470.542 | 3470.541 | ±0.200 | -0.001 | Pass |
| | Surface Point Y | -143.730 | -143.730 | ±0.200 | 0.000 | Pass |
| | Surface Point Z | 366.055 | 366.107 | ±0.200 | 0.052 | Pass |

Customer: HONDA DE MEXICO
 Operator: Felipe Martinez
 E-mail: felipe.martinez@mess.com.mx

Part name: B-ZYD25C
 Part number: 71501/2-3W0-ZZ00/A000
 Piece: piece 1

