



Programme All Characteristics	Plan Name 2980732XXX placa	Date 2025-03-06	Temperature workpiece	Drawing No. 2980732XXX
Incremental Part Number 1	Audit-No.: * vda_auditno *	Time 2:33:59 pm	Operator Master	Revision Date

Dat 3			
	Act	Nom	Dev
X	2584.672	2584.672	0.000
Y	-754.989	-754.987	-0.002
Z	1263.224	1263.219	0.005

Dat 2			
	Act	Nom	Dev
X	2531.202	2531.202	0.000
Y	-165.071	-165.072	0.000
Z	1699.916	1699.916	0.000

Dat 1			
	Act	Nom	Dev
X	2531.183	2531.183	0.000
Y	-754.992	-754.992	0.000
Z	1699.911	1699.911	0.000

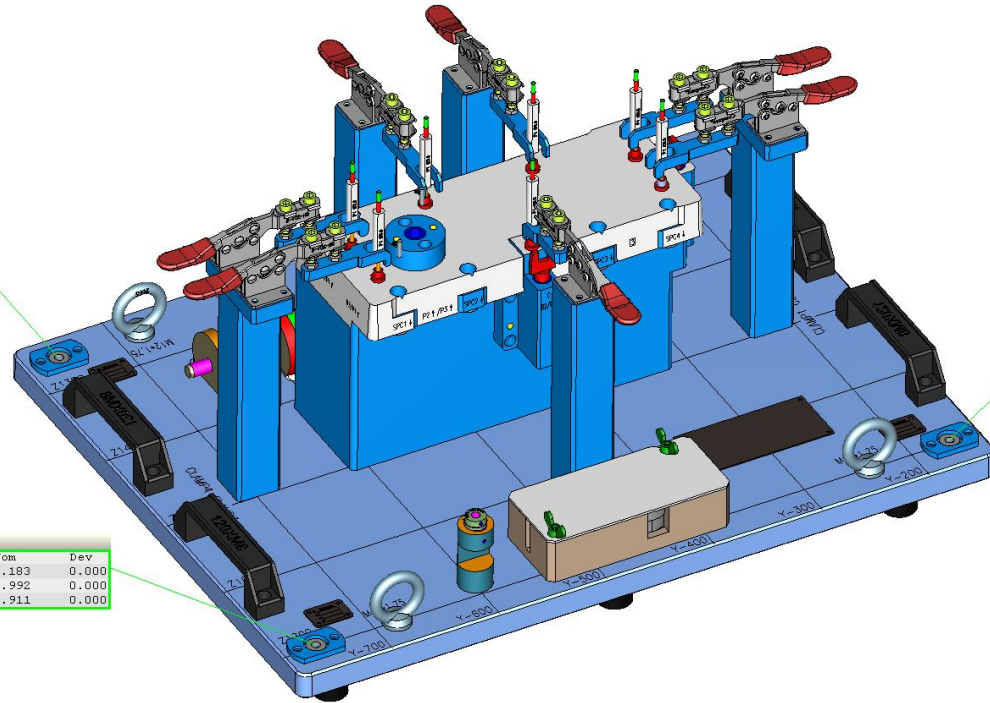

100 mm





Programme All Characteristics	Plan Name 2980732XXX placa	Date 2025-03-06	Temperature workpiece	Drawing No. 2980732XXX
Incremental Part Number 1	Audit-No.: * vda_auditno *	Time 2:33:59 pm	Operator Master	Revision Date

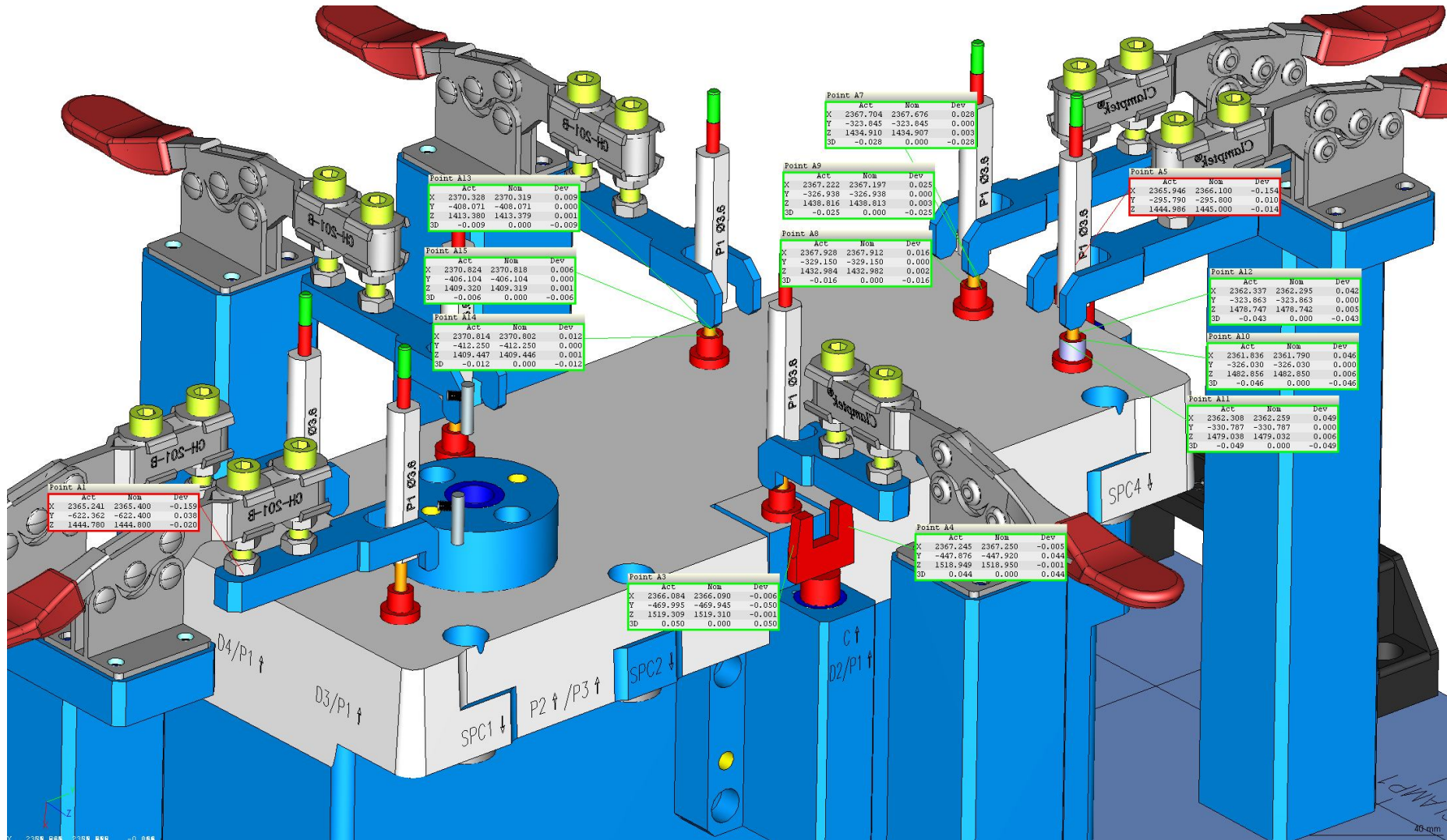



Programme All Characteristics	Plan Name 2980732XXX placa	Date 2025-03-06	Temperature workpiece	Drawing No. 2980732XXX
Incremental Part Number 1	Audit-No.: * vda_auditno *	Time 2:33:59 pm	Operator Master	Revision Date

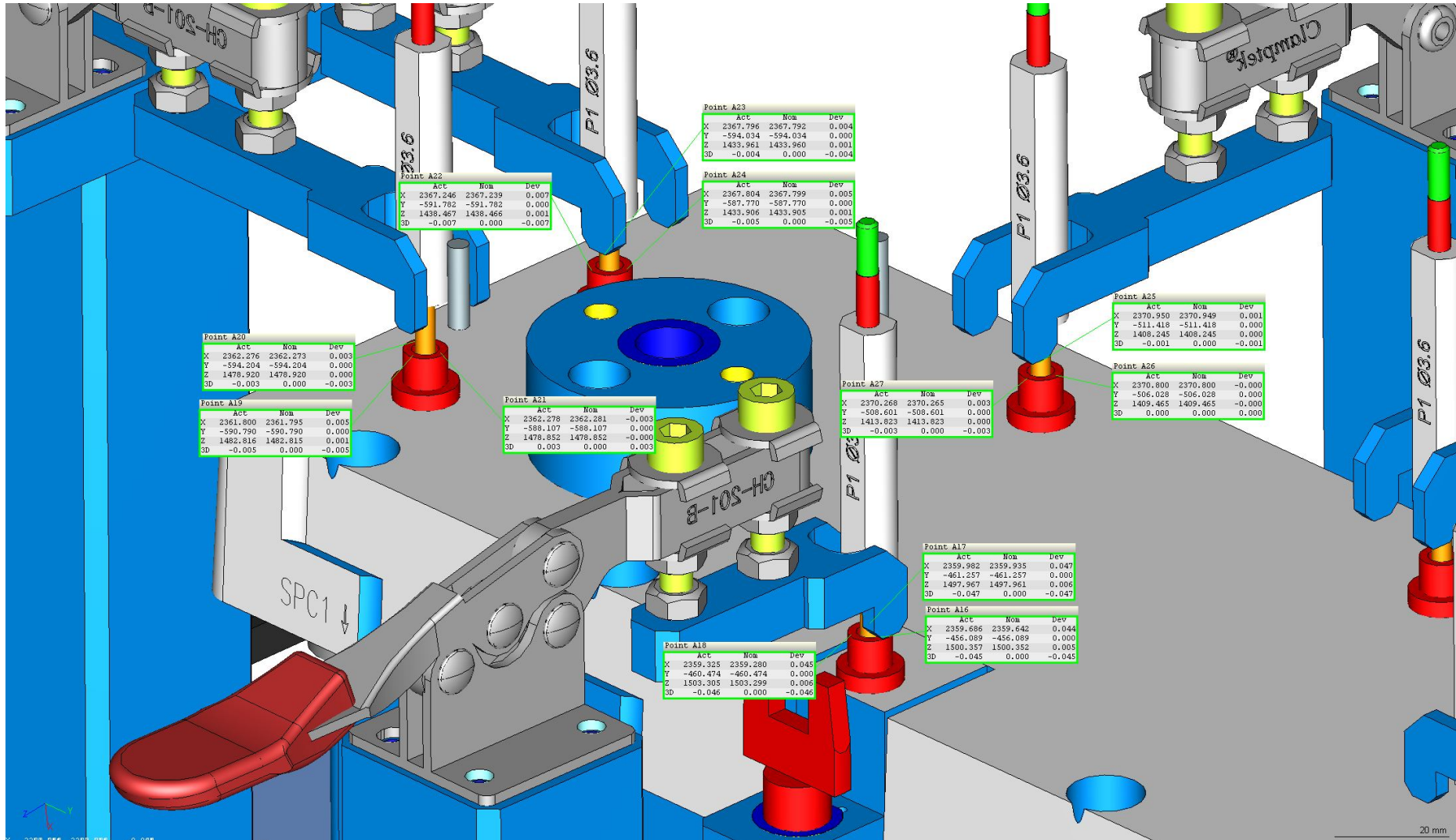



Programme All Characteristics	Plan Name 2980732XXX placa	Date 2025-03-06	Temperature workpiece	Drawing No. 2980732XXX
Incremental Part Number 1	Audit-No.: * vda_auditno *	Time 2:33:59 pm	Operator Master	Revision Date

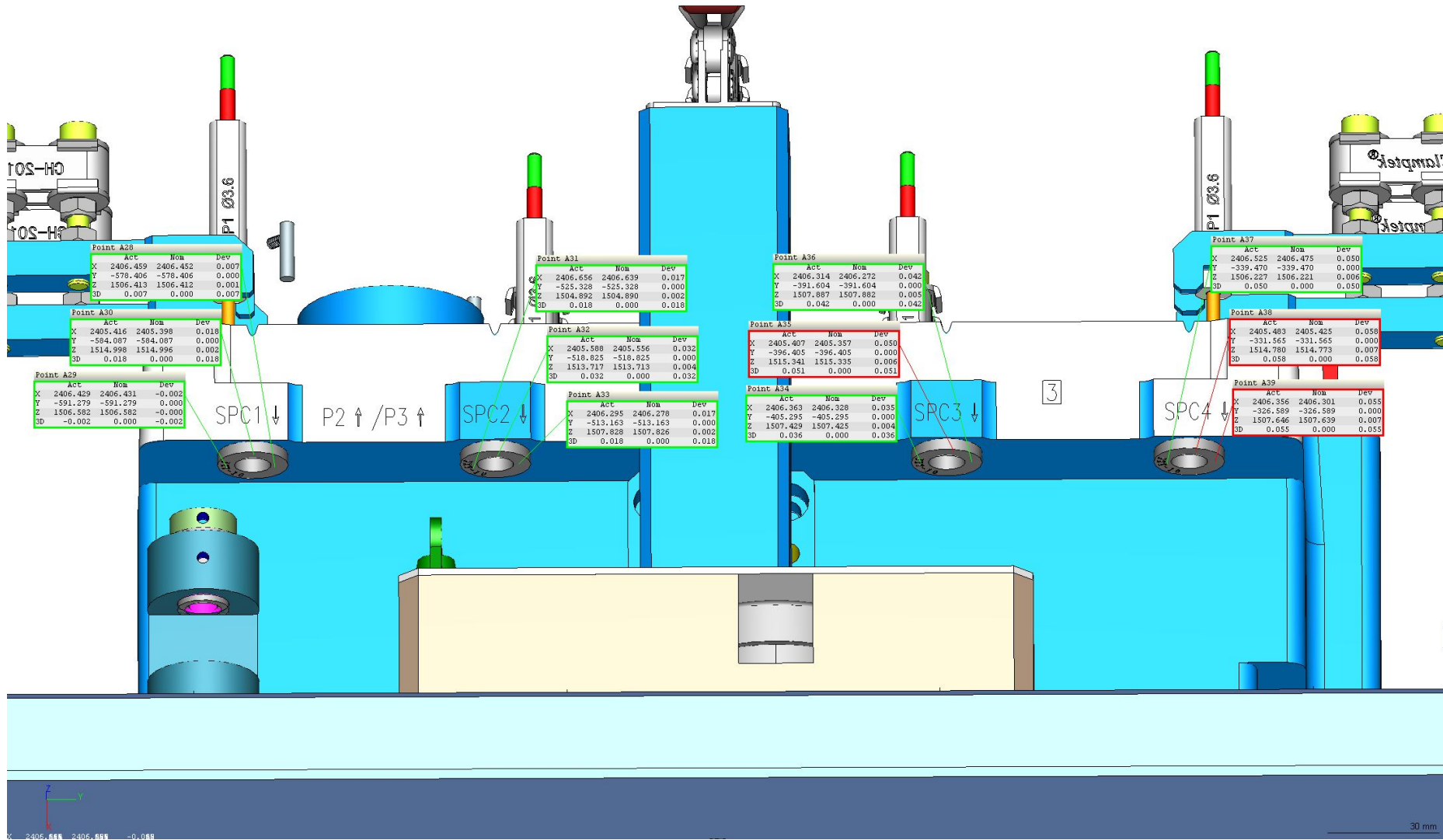



Programme All Characteristics	Plan Name 2980732XXX placa	Date 2025-03-06	Temperature workpiece	Drawing No. 2980732XXX
Incremental Part Number 1	Audit-No.: * vda_auditno *	Time 2:33:59 pm	Operator Master	Revision Date

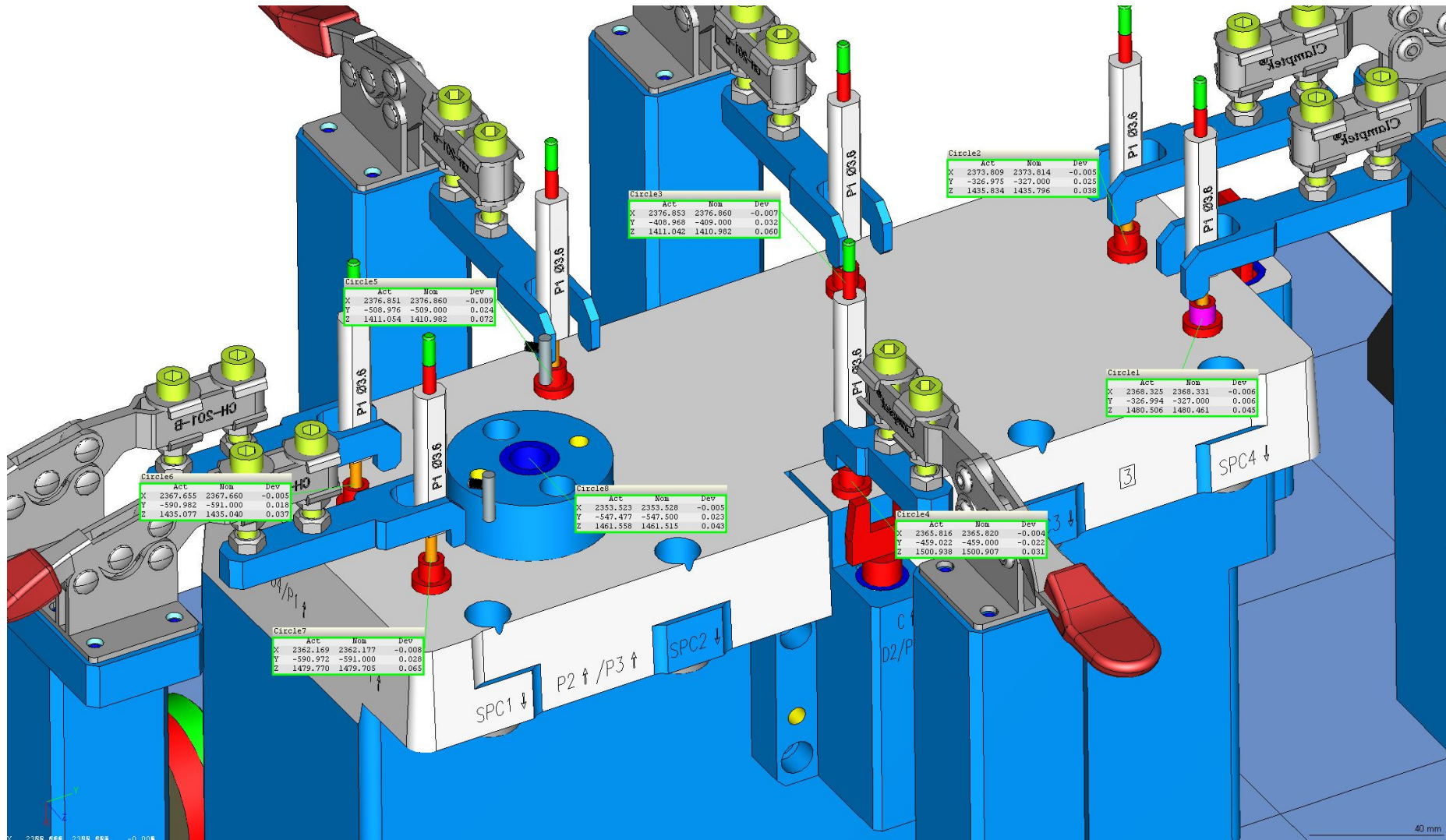



Programme All Characteristics	Plan Name 2980732XXX placa	Date 2025-03-06	Temperature workpiece	Drawing No. 2980732XXX
Incremental Part Number 1	Audit-No.: * vda_auditno *	Time 2:33:59 pm	Operator Master	Revision Date

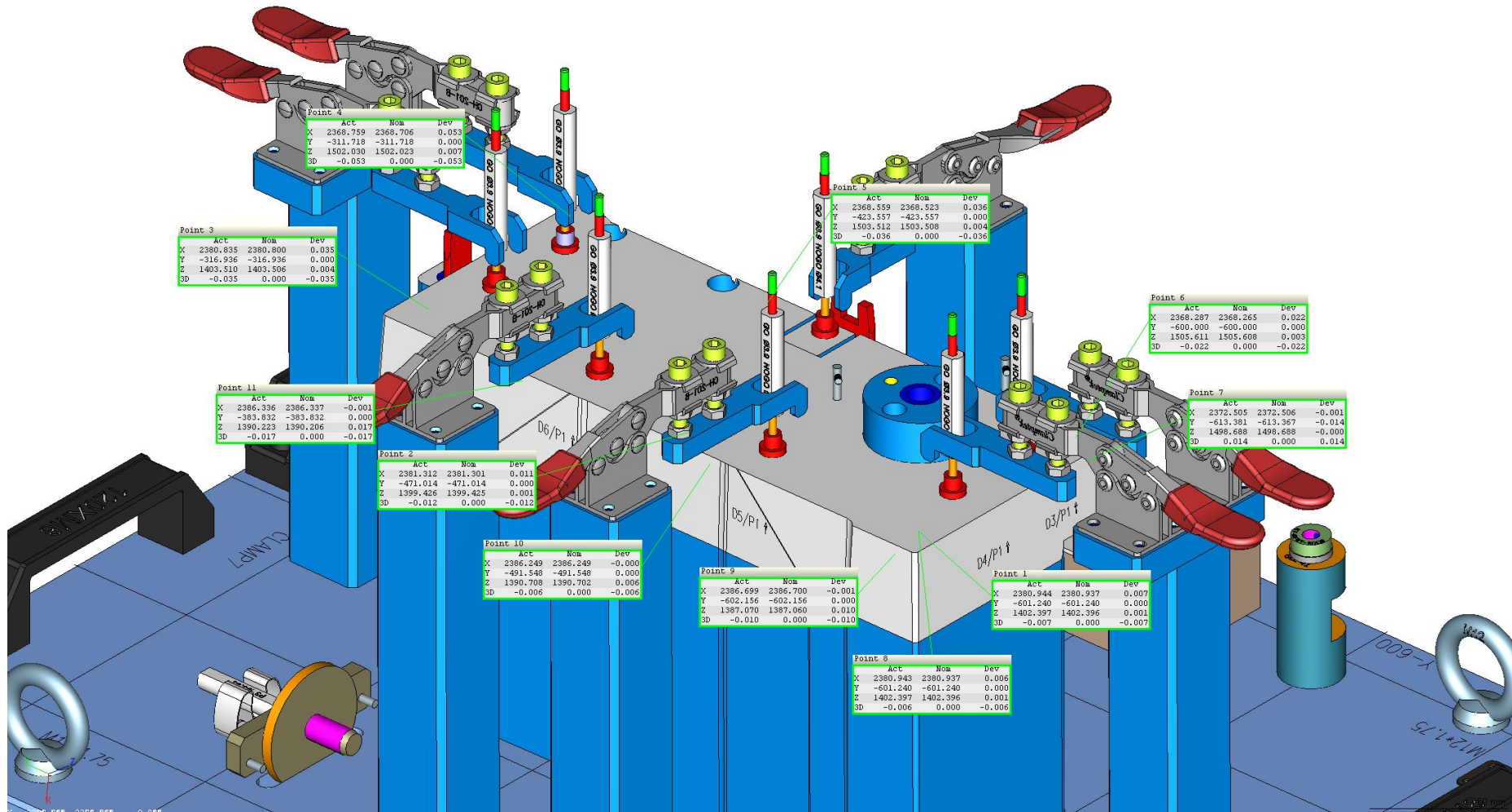



Programme All Characteristics	Plan Name 2980732XXX placa	Date 2025-03-06	Temperature workpiece	Drawing No. 2980732XXX
Incremental Part Number 1	Audit-No.: * vda_auditno *	Time 2:33:59 pm	Operator Master	Revision Date

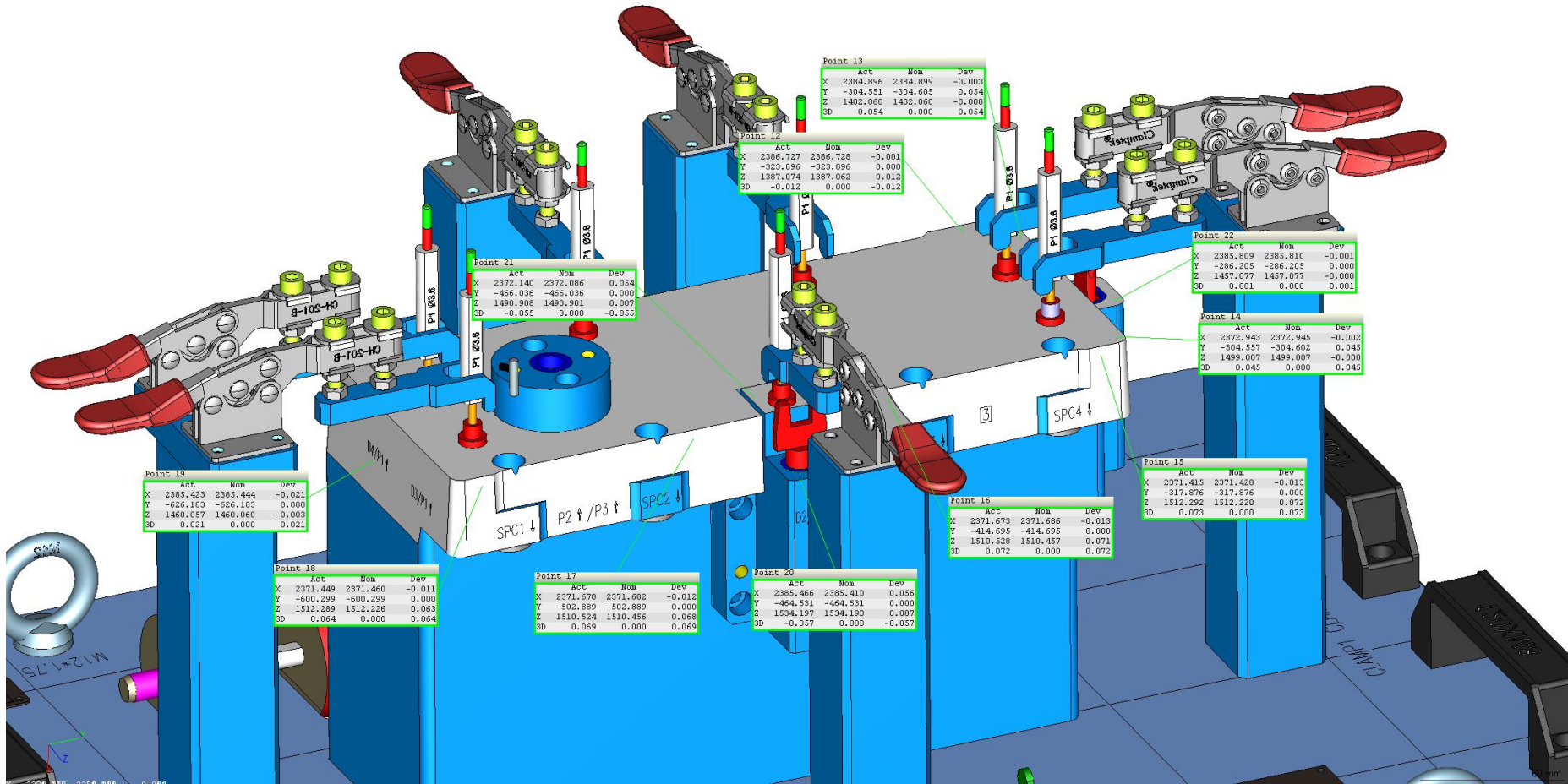

Part Name
Fixture

Drawing No.
2980732XXX

Customer
Centracore

Metrologist
Gerardo Moctezuma

Length unit
mm

No. de pieza
1

Name	ID	Actual	Nominal	pos Tol	neg Tol	Diff	<-- -->
------	----	--------	---------	---------	---------	------	---------

Alignment

X Value_Dat 1	X	2531.183	2531.183	0.050	-0.050	0.000	
Y Value_Dat 1	Y	-754.992	-754.992	0.050	-0.050	0.000	
Z Value_Dat 1	Z	1699.911	1699.911	0.050	-0.050	0.000	
X Value_Dat 2	X	2531.202	2531.202	0.050	-0.050	0.000	
Y Value_Dat 2	Y	-165.071	-165.072	0.050	-0.050	0.000	
Z Value_Dat 2	Z	1699.916	1699.916	0.050	-0.050	0.000	
X Value_Dat 3	X	2584.672	2584.672	0.050	-0.050	0.000	
Y Value_Dat 3	Y	-754.989	-754.987	0.050	-0.050	-0.002	-
Z Value_Dat 3	Z	1263.224	1263.219	0.050	-0.050	0.005	-

+++++

X Value_Point A1	X	2365.241	2365.400	0.050	-0.050	-0.159	-0.109
Y Value_Point A1	Y	-622.362	-622.400	0.050	-0.050	0.038	----
Z Value_Point A1	Z	1444.780	1444.800	0.050	-0.050	-0.020	--
X Value_Point A3	X	2366.084	2366.090	0.050	-0.050	-0.006	-
Y Value_Point A3	Y	-469.995	-469.945	0.050	-0.050	-0.050	----
Z Value_Point A3	Z	1519.309	1519.310	0.050	-0.050	-0.001	
Space Point Distance_Point A3	PtDist	0.050	0.000	0.050	-0.050	0.050	----
X Value_Point A4	X	2367.245	2367.250	0.050	-0.050	-0.005	-
Y Value_Point A4	Y	-447.876	-447.920	0.050	-0.050	0.044	----
Z Value_Point A4	Z	1518.949	1518.950	0.050	-0.050	-0.001	
Space Point Distance_Point A4	PtDist	0.044	0.000	0.050	-0.050	0.044	----
X Value_Point A5	X	2365.946	2366.100	0.050	-0.050	-0.154	-0.104
Y Value_Point A5	Y	-295.790	-295.800	0.050	-0.050	0.010	-
Z Value_Point A5	Z	1444.986	1445.000	0.050	-0.050	-0.014	--
X Value_Point A7	X	2367.704	2367.676	0.050	-0.050	0.028	---
Y Value_Point A7	Y	-323.845	-323.845	0.050	-0.050	0.000	
Z Value_Point A7	Z	1434.910	1434.907	0.050	-0.050	0.003	-
Space Point Distance_Point A7	PtDist	-0.028	0.000	0.050	-0.050	-0.028	---
X Value_Point A8	X	2367.928	2367.912	0.050	-0.050	0.016	--
Y Value_Point A8	Y	-329.150	-329.150	0.050	-0.050	0.000	
Z Value_Point A8	Z	1432.984	1432.982	0.050	-0.050	0.002	-





Name	id	actual	nominal	pos tol	neg tol	diff	<-- -->
Space Point Distance_Point A8	PtDist	-0.016	0.000	0.050	-0.050	-0.016	--
X Value_Point A9	X	2367.222	2367.197	0.050	-0.050	0.025	--
Y Value_Point A9	Y	-326.938	-326.938	0.050	-0.050	0.000	
Z Value_Point A9	Z	1438.816	1438.813	0.050	-0.050	0.003	-
Space Point Distance_Point A9	PtDist	-0.025	0.000	0.050	-0.050	-0.025	--
X Value_Point A10	X	2361.836	2361.790	0.050	-0.050	0.046	----
Y Value_Point A10	Y	-326.030	-326.030	0.050	-0.050	0.000	
Z Value_Point A10	Z	1482.856	1482.850	0.050	-0.050	0.006	-
Space Point Distance_Point A10	PtDist	-0.046	0.000	0.050	-0.050	-0.046	----
X Value_Point A11	X	2362.308	2362.259	0.050	-0.050	0.049	----
Y Value_Point A11	Y	-330.787	-330.787	0.050	-0.050	0.000	
Z Value_Point A11	Z	1479.038	1479.032	0.050	-0.050	0.006	-
Space Point Distance_Point A11	PtDist	-0.049	0.000	0.050	-0.050	-0.049	----
X Value_Point A12	X	2362.337	2362.295	0.050	-0.050	0.042	----
Y Value_Point A12	Y	-323.863	-323.863	0.050	-0.050	0.000	
Z Value_Point A12	Z	1478.747	1478.742	0.050	-0.050	0.005	-
Space Point Distance_Point A12	PtDist	-0.043	0.000	0.050	-0.050	-0.043	----
X Value_Point A13	X	2370.328	2370.319	0.050	-0.050	0.009	-
Y Value_Point A13	Y	-408.071	-408.071	0.050	-0.050	0.000	
Z Value_Point A13	Z	1413.380	1413.379	0.050	-0.050	0.001	
Space Point Distance_Point A13	PtDist	-0.009	0.000	0.050	-0.050	-0.009	-
X Value_Point A14	X	2370.814	2370.802	0.050	-0.050	0.012	-
Y Value_Point A14	Y	-412.250	-412.250	0.050	-0.050	0.000	
Z Value_Point A14	Z	1409.447	1409.446	0.050	-0.050	0.001	
Space Point Distance_Point A14	PtDist	-0.012	0.000	0.050	-0.050	-0.012	-
X Value_Point A15	X	2370.824	2370.818	0.050	-0.050	0.006	-
Y Value_Point A15	Y	-406.104	-406.104	0.050	-0.050	0.000	
Z Value_Point A15	Z	1409.320	1409.319	0.050	-0.050	0.001	
Space Point Distance_Point A15	PtDist	-0.006	0.000	0.050	-0.050	-0.006	-
X Value_Point A16	X	2359.686	2359.642	0.050	-0.050	0.044	----
Y Value_Point A16	Y	-456.089	-456.089	0.050	-0.050	0.000	
Z Value_Point A16	Z	1500.357	1500.352	0.050	-0.050	0.005	-
Space Point Distance_Point A16	PtDist	-0.045	0.000	0.050	-0.050	-0.045	----
X Value_Point A17	X	2359.982	2359.935	0.050	-0.050	0.047	----
Y Value_Point A17	Y	-461.257	-461.257	0.050	-0.050	0.000	
Z Value_Point A17	Z	1497.967	1497.961	0.050	-0.050	0.006	-
Space Point Distance_Point A17	PtDist	-0.047	0.000	0.050	-0.050	-0.047	----
X Value_Point A18	X	2359.325	2359.280	0.050	-0.050	0.045	----
Y Value_Point A18	Y	-460.474	-460.474	0.050	-0.050	0.000	
Z Value_Point A18	Z	1503.305	1503.299	0.050	-0.050	0.006	-
Space Point Distance_Point A18	PtDist	-0.046	0.000	0.050	-0.050	-0.046	----
X Value_Point A19	X	2361.800	2361.795	0.050	-0.050	0.005	-





Name	id	actual	nominal	pos tol	neg tol	diff	<-- -->
Y Value_Point A19	Y	-590.790	-590.790	0.050	-0.050	0.000	
Z Value_Point A19	Z	1482.816	1482.815	0.050	-0.050	0.001	
Space Point Distance_Point A19	PtDist	-0.005	0.000	0.050	-0.050	-0.005	-
X Value_Point A20	X	2362.276	2362.273	0.050	-0.050	0.003	-
Y Value_Point A20	Y	-594.204	-594.204	0.050	-0.050	0.000	
Z Value_Point A20	Z	1478.920	1478.920	0.050	-0.050	0.000	
Space Point Distance_Point A20	PtDist	-0.003	0.000	0.050	-0.050	-0.003	-
X Value_Point A21	X	2362.278	2362.281	0.050	-0.050	-0.003	-
Y Value_Point A21	Y	-588.107	-588.107	0.050	-0.050	0.000	
Z Value_Point A21	Z	1478.852	1478.852	0.050	-0.050	0.000	
Space Point Distance_Point A21	PtDist	0.003	0.000	0.050	-0.050	0.003	-
X Value_Point A22	X	2367.246	2367.239	0.050	-0.050	0.007	-
Y Value_Point A22	Y	-591.782	-591.782	0.050	-0.050	0.000	
Z Value_Point A22	Z	1438.467	1438.466	0.050	-0.050	0.001	
Space Point Distance_Point A22	PtDist	-0.007	0.000	0.050	-0.050	-0.007	-
X Value_Point A23	X	2367.796	2367.792	0.050	-0.050	0.004	-
Y Value_Point A23	Y	-594.034	-594.034	0.050	-0.050	0.000	
Z Value_Point A23	Z	1433.961	1433.960	0.050	-0.050	0.001	
Space Point Distance_Point A23	PtDist	-0.004	0.000	0.050	-0.050	-0.004	-
X Value_Point A24	X	2367.804	2367.799	0.050	-0.050	0.005	-
Y Value_Point A24	Y	-587.770	-587.770	0.050	-0.050	0.000	
Z Value_Point A24	Z	1433.906	1433.905	0.050	-0.050	0.001	
Space Point Distance_Point A24	PtDist	-0.005	0.000	0.050	-0.050	-0.005	-
X Value_Point A25	X	2370.950	2370.949	0.050	-0.050	0.001	
Y Value_Point A25	Y	-511.418	-511.418	0.050	-0.050	0.000	
Z Value_Point A25	Z	1408.245	1408.245	0.050	-0.050	0.000	
Space Point Distance_Point A25	PtDist	-0.001	0.000	0.050	-0.050	-0.001	
X Value_Point A26	X	2370.800	2370.800	0.050	-0.050	0.000	
Y Value_Point A26	Y	-506.028	-506.028	0.050	-0.050	0.000	
Z Value_Point A26	Z	1409.465	1409.465	0.050	-0.050	0.000	
Space Point Distance_Point A26	PtDist	0.000	0.000	0.050	-0.050	0.000	
X Value_Point A27	X	2370.268	2370.265	0.050	-0.050	0.003	-
Y Value_Point A27	Y	-508.601	-508.601	0.050	-0.050	0.000	
Z Value_Point A27	Z	1413.823	1413.823	0.050	-0.050	0.000	
Space Point Distance_Point A27	PtDist	-0.003	0.000	0.050	-0.050	-0.003	-
X Value_Point A28	X	2406.459	2406.452	0.050	-0.050	0.007	-
Y Value_Point A28	Y	-578.406	-578.406	0.050	-0.050	0.000	
Z Value_Point A28	Z	1506.413	1506.412	0.050	-0.050	0.001	
Space Point Distance_Point A28	PtDist	0.007	0.000	0.050	-0.050	0.007	-
X Value_Point A29	X	2406.429	2406.431	0.050	-0.050	-0.002	-
Y Value_Point A29	Y	-591.279	-591.279	0.050	-0.050	0.000	
Z Value_Point A29	Z	1506.582	1506.582	0.050	-0.050	0.000	





Name	id	actual	nominal	pos tol	neg tol	diff	<-- -->
Space Point Distance_Point A29	PtDist	-0.002	0.000	0.050	-0.050	-0.002	-
X Value_Point A30	X	2405.416	2405.398	0.050	-0.050	0.018	--
Y Value_Point A30	Y	-584.087	-584.087	0.050	-0.050	0.000	
Z Value_Point A30	Z	1514.998	1514.996	0.050	-0.050	0.002	-
Space Point Distance_Point A30	PtDist	0.018	0.000	0.050	-0.050	0.018	--
X Value_Point A31	X	2406.656	2406.639	0.050	-0.050	0.017	--
Y Value_Point A31	Y	-525.328	-525.328	0.050	-0.050	0.000	
Z Value_Point A31	Z	1504.892	1504.890	0.050	-0.050	0.002	-
Space Point Distance_Point A31	PtDist	0.018	0.000	0.050	-0.050	0.018	--
X Value_Point A32	X	2405.588	2405.556	0.050	-0.050	0.032	---
Y Value_Point A32	Y	-518.825	-518.825	0.050	-0.050	0.000	
Z Value_Point A32	Z	1513.717	1513.713	0.050	-0.050	0.004	-
Space Point Distance_Point A32	PtDist	0.032	0.000	0.050	-0.050	0.032	---
X Value_Point A33	X	2406.295	2406.278	0.050	-0.050	0.017	--
Y Value_Point A33	Y	-513.163	-513.163	0.050	-0.050	0.000	
Z Value_Point A33	Z	1507.828	1507.826	0.050	-0.050	0.002	-
Space Point Distance_Point A33	PtDist	0.018	0.000	0.050	-0.050	0.018	--
X Value_Point A34	X	2406.363	2406.328	0.050	-0.050	0.035	---
Y Value_Point A34	Y	-405.295	-405.295	0.050	-0.050	0.000	
Z Value_Point A34	Z	1507.429	1507.425	0.050	-0.050	0.004	-
Space Point Distance_Point A34	PtDist	0.036	0.000	0.050	-0.050	0.036	---
X Value_Point A35	X	2405.407	2405.357	0.050	-0.050	0.050	----
Y Value_Point A35	Y	-396.405	-396.405	0.050	-0.050	0.000	
Z Value_Point A35	Z	1515.341	1515.335	0.050	-0.050	0.006	-
Space Point Distance_Point A35	PtDist	0.051	0.000	0.050	-0.050	0.051	0.001
X Value_Point A36	X	2406.314	2406.272	0.050	-0.050	0.042	----
Y Value_Point A36	Y	-391.604	-391.604	0.050	-0.050	0.000	
Z Value_Point A36	Z	1507.887	1507.882	0.050	-0.050	0.005	-
Space Point Distance_Point A36	PtDist	0.042	0.000	0.050	-0.050	0.042	----
X Value_Point A37	X	2406.525	2406.475	0.050	-0.050	0.050	----
Y Value_Point A37	Y	-339.470	-339.470	0.050	-0.050	0.000	
Z Value_Point A37	Z	1506.227	1506.221	0.050	-0.050	0.006	-
Space Point Distance_Point A37	PtDist	0.050	0.000	0.050	-0.050	0.050	----
X Value_Point A38	X	2405.483	2405.425	0.050	-0.050	0.058	0.008
Y Value_Point A38	Y	-331.565	-331.565	0.050	-0.050	0.000	
Z Value_Point A38	Z	1514.780	1514.773	0.050	-0.050	0.007	-
Space Point Distance_Point A38	PtDist	0.058	0.000	0.050	-0.050	0.058	0.008
X Value_Point A39	X	2406.356	2406.301	0.050	-0.050	0.055	0.005
Y Value_Point A39	Y	-326.589	-326.589	0.050	-0.050	0.000	
Z Value_Point A39	Z	1507.646	1507.639	0.050	-0.050	0.007	-
Space Point Distance_Point A39	PtDist	0.055	0.000	0.050	-0.050	0.055	0.005





Name	id	actual	nominal	pos tol	neg tol	diff	<-- -->
------	----	--------	---------	---------	---------	------	---------

++++++

X Value_Circle1	X	2368.325	2368.331	0.100	-0.100	-0.006	-
Y Value_Circle1	Y	-326.994	-327.000	0.100	-0.100	0.006	-
Z Value_Circle1	Z	1480.506	1480.461	0.100	-0.100	0.045	--
X Value_Circle2	X	2373.809	2373.814	0.100	-0.100	-0.005	-
Y Value_Circle2	Y	-326.975	-327.000	0.100	-0.100	0.025	-
Z Value_Circle2	Z	1435.834	1435.796	0.100	-0.100	0.038	--
X Value_Circle3	X	2376.853	2376.860	0.100	-0.100	-0.007	-
Y Value_Circle3	Y	-408.968	-409.000	0.100	-0.100	0.032	--
Z Value_Circle3	Z	1411.042	1410.982	0.100	-0.100	0.060	---
X Value_Circle4	X	2365.816	2365.820	0.100	-0.100	-0.004	-
Y Value_Circle4	Y	-459.022	-459.000	0.100	-0.100	-0.022	-
Z Value_Circle4	Z	1500.938	1500.907	0.100	-0.100	0.031	--
X Value_Circle5	X	2376.851	2376.860	0.100	-0.100	-0.009	-
Y Value_Circle5	Y	-508.976	-509.000	0.100	-0.100	0.024	-
Z Value_Circle5	Z	1411.054	1410.982	0.100	-0.100	0.072	---
X Value_Circle6	X	2367.655	2367.660	0.100	-0.100	-0.005	-
Y Value_Circle6	Y	-590.982	-591.000	0.100	-0.100	0.018	-
Z Value_Circle6	Z	1435.077	1435.040	0.100	-0.100	0.037	--
X Value_Circle7	X	2362.169	2362.177	0.100	-0.100	-0.008	-
Y Value_Circle7	Y	-590.972	-591.000	0.100	-0.100	0.028	--
Z Value_Circle7	Z	1479.770	1479.705	0.100	-0.100	0.065	---
X Value_Circle8	X	2353.523	2353.528	0.100	-0.100	-0.005	-
Y Value_Circle8	Y	-547.477	-547.500	0.100	-0.100	0.023	-
Z Value_Circle8	Z	1461.558	1461.515	0.100	-0.100	0.043	--

++++++

X Value_Point 1	X	2380.944	2380.937	0.100	-0.100	0.007	-
Y Value_Point 1	Y	-601.240	-601.240	0.100	-0.100	0.000	
Z Value_Point 1	Z	1402.397	1402.396	0.100	-0.100	0.001	
Space Point Distance_Point 1	PtDist	-0.007	0.000	0.100	-0.100	-0.007	-
X Value_Point 2	X	2381.312	2381.301	0.100	-0.100	0.011	-
Y Value_Point 2	Y	-471.014	-471.014	0.100	-0.100	0.000	
Z Value_Point 2	Z	1399.426	1399.425	0.100	-0.100	0.001	
Space Point Distance_Point 2	PtDist	-0.012	0.000	0.100	-0.100	-0.012	-
X Value_Point 3	X	2380.835	2380.800	0.100	-0.100	0.035	--
Y Value_Point 3	Y	-316.936	-316.936	0.100	-0.100	0.000	
Z Value_Point 3	Z	1403.510	1403.506	0.100	-0.100	0.004	-
Space Point Distance_Point 3	PtDist	-0.035	0.000	0.100	-0.100	-0.035	--
X Value_Point 4	X	2368.759	2368.706	0.100	-0.100	0.053	---
Y Value_Point 4	Y	-311.718	-311.718	0.100	-0.100	0.000	





Name	id	actual	nominal	pos tol	neg tol	diff	<-- -->
Z Value_Point 4	Z	1502.030	1502.023	0.100	-0.100	0.007	-
Space Point Distance_Point 4	PtDist	-0.053	0.000	0.100	-0.100	-0.053	---
X Value_Point 5	X	2368.559	2368.523	0.100	-0.100	0.036	--
Y Value_Point 5	Y	-423.557	-423.557	0.100	-0.100	0.000	
Z Value_Point 5	Z	1503.512	1503.508	0.100	-0.100	0.004	-
Space Point Distance_Point 5	PtDist	-0.036	0.000	0.100	-0.100	-0.036	--
X Value_Point 6	X	2368.287	2368.265	0.100	-0.100	0.022	-
Y Value_Point 6	Y	-600.000	-600.000	0.100	-0.100	0.000	
Z Value_Point 6	Z	1505.611	1505.608	0.100	-0.100	0.003	-
Space Point Distance_Point 6	PtDist	-0.022	0.000	0.100	-0.100	-0.022	-
X Value_Point 7	X	2372.505	2372.506	0.100	-0.100	-0.001	
Y Value_Point 7	Y	-613.381	-613.367	0.100	-0.100	-0.014	-
Z Value_Point 7	Z	1498.688	1498.688	0.100	-0.100	0.000	
Space Point Distance_Point 7	PtDist	0.014	0.000	0.100	-0.100	0.014	-
X Value_Point 8	X	2380.943	2380.937	0.100	-0.100	0.006	-
Y Value_Point 8	Y	-601.240	-601.240	0.100	-0.100	0.000	
Z Value_Point 8	Z	1402.397	1402.396	0.100	-0.100	0.001	
Space Point Distance_Point 8	PtDist	-0.006	0.000	0.100	-0.100	-0.006	-
X Value_Point 9	X	2386.699	2386.700	0.100	-0.100	-0.001	
Y Value_Point 9	Y	-602.156	-602.156	0.100	-0.100	0.000	
Z Value_Point 9	Z	1387.070	1387.060	0.100	-0.100	0.010	-
Space Point Distance_Point 9	PtDist	-0.010	0.000	0.100	-0.100	-0.010	-
X Value_Point 10	X	2386.249	2386.249	0.100	-0.100	0.000	
Y Value_Point 10	Y	-491.548	-491.548	0.100	-0.100	0.000	
Z Value_Point 10	Z	1390.708	1390.702	0.100	-0.100	0.006	-
Space Point Distance_Point 10	PtDist	-0.006	0.000	0.100	-0.100	-0.006	-
X Value_Point 11	X	2386.336	2386.337	0.100	-0.100	-0.001	
Y Value_Point 11	Y	-383.832	-383.832	0.100	-0.100	0.000	
Z Value_Point 11	Z	1390.223	1390.206	0.100	-0.100	0.017	-
Space Point Distance_Point 11	PtDist	-0.017	0.000	0.100	-0.100	-0.017	-
X Value_Point 12	X	2386.727	2386.728	0.100	-0.100	-0.001	
Y Value_Point 12	Y	-323.896	-323.896	0.100	-0.100	0.000	
Z Value_Point 12	Z	1387.074	1387.062	0.100	-0.100	0.012	-
Space Point Distance_Point 12	PtDist	-0.012	0.000	0.100	-0.100	-0.012	-
X Value_Point 13	X	2384.896	2384.899	0.100	-0.100	-0.003	-
Y Value_Point 13	Y	-304.551	-304.605	0.100	-0.100	0.054	---
Z Value_Point 13	Z	1402.060	1402.060	0.100	-0.100	0.000	
Space Point Distance_Point 13	PtDist	0.054	0.000	0.100	-0.100	0.054	---
X Value_Point 14	X	2372.943	2372.945	0.100	-0.100	-0.002	-
Y Value_Point 14	Y	-304.557	-304.602	0.100	-0.100	0.045	--
Z Value_Point 14	Z	1499.807	1499.807	0.100	-0.100	0.000	
Space Point Distance_Point 14	PtDist	0.045	0.000	0.100	-0.100	0.045	--





Name	id	actual	nominal	pos tol	neg tol	diff	<-- -->
X Value_Point 15	X	2371.415	2371.428	0.100	-0.100	-0.013	-
Y Value_Point 15	Y	-317.876	-317.876	0.100	-0.100	0.000	
Z Value_Point 15	Z	1512.292	1512.220	0.100	-0.100	0.072	---
Space Point Distance_Point 15	PtDist	0.073	0.000	0.100	-0.100	0.073	---
X Value_Point 16	X	2371.673	2371.686	0.100	-0.100	-0.013	-
Y Value_Point 16	Y	-414.695	-414.695	0.100	-0.100	0.000	
Z Value_Point 16	Z	1510.528	1510.457	0.100	-0.100	0.071	---
Space Point Distance_Point 16	PtDist	0.072	0.000	0.100	-0.100	0.072	---
X Value_Point 17	X	2371.670	2371.682	0.100	-0.100	-0.012	-
Y Value_Point 17	Y	-502.889	-502.889	0.100	-0.100	0.000	
Z Value_Point 17	Z	1510.524	1510.456	0.100	-0.100	0.068	---
Space Point Distance_Point 17	PtDist	0.069	0.000	0.100	-0.100	0.069	---
X Value_Point 18	X	2371.449	2371.460	0.100	-0.100	-0.011	-
Y Value_Point 18	Y	-600.299	-600.299	0.100	-0.100	0.000	
Z Value_Point 18	Z	1512.289	1512.226	0.100	-0.100	0.063	---
Space Point Distance_Point 18	PtDist	0.064	0.000	0.100	-0.100	0.064	---
X Value_Point 19	X	2385.423	2385.444	0.100	-0.100	-0.021	-
Y Value_Point 19	Y	-626.183	-626.183	0.100	-0.100	0.000	
Z Value_Point 19	Z	1460.057	1460.060	0.100	-0.100	-0.003	-
Space Point Distance_Point 19	PtDist	0.021	0.000	0.100	-0.100	0.021	-
X Value_Point 20	X	2385.466	2385.410	0.100	-0.100	0.056	---
Y Value_Point 20	Y	-464.531	-464.531	0.100	-0.100	0.000	
Z Value_Point 20	Z	1534.197	1534.190	0.100	-0.100	0.007	-
Space Point Distance_Point 20	PtDist	-0.057	0.000	0.100	-0.100	-0.057	---
X Value_Point 21	X	2372.140	2372.086	0.100	-0.100	0.054	---
Y Value_Point 21	Y	-466.036	-466.036	0.100	-0.100	0.000	
Z Value_Point 21	Z	1490.908	1490.901	0.100	-0.100	0.007	-
Space Point Distance_Point 21	PtDist	-0.055	0.000	0.100	-0.100	-0.055	---
X Value_Point 22	X	2385.809	2385.810	0.100	-0.100	-0.001	
Y Value_Point 22	Y	-286.205	-286.205	0.100	-0.100	0.000	
Z Value_Point 22	Z	1457.077	1457.077	0.100	-0.100	0.000	
Space Point Distance_Point 22	PtDist	0.001	0.000	0.100	-0.100	0.001	

